

**NINZ**<sup>®</sup>  
FIREDOORS

## REVER multipurpose doors

**"bare minimum, maximum performance!"**





## **NINZ REVER multipurpose doors**

FEATURES	2 - 5
SPECIFIC OPTIONAL ACCESSORIES	6 - 9
DOOR CROSS SECTIONS - MEASUREMENTS	10
INSTALLATION METHODS	11
ORDER MEASUREMENTS	12
OPENING MEASUREMENTS - ENCUMBRANCE	13
PAINTING, NDD <sup>®</sup>	14 - 19
ACCESSOIRES	20 - 39
DEVICES	40 - 75

# Features

## REVER multipurpose doors

### THE ECONOMICAL MULTIPURPOSE YOU ALWAYS WISHED FOR

#### “Quality first”

- Fully galvanized, including the “hidden” parts
- Made of “Sendzimir” processed hot-galvanized sheet metal
- Corrosion protection also provided along the cut edges of the metal
- Painted with epoxy-polyester thermoset powders in a 180 degree (Celsius) oven
- Extra-thick paint layer (over 70 microns)
- Optimal corrosion resistance as demonstrated by 500 hour salt-fog testing
- Finishing with high-quality aesthetics
- Orange skin anti-scratch structured paint
- Customizable with wide selection of RAL colors

#### “Practicality of use”

- Door reversibility\*
- Indication of door opening direction not necessary
- Reduction of stock for retailers
- Simplifies choices for end customers
- Especially well-suited for indoor use
- Light but still sturdy
- Easy installation

#### “Versatility”

- Very wide field of application
- Can be combined with various frame types
- Installable onto any wall type
- Application with a block frame
- Can be combined with over-head frame panel with or without ventilating perforation
- Available with upper/lower crack enlargement
- Vast assortment of accessories
- Customized measurements also available

#### “Manufacturing technology”

- Manufacturing in modern and functional facilities which employ the latest technologies to maintain high quality levels and product uniformity
- The entire production process - from raw materials to painted and packaged products - takes place inside Ninz’s own facilities, ensuring a 360 degree door control

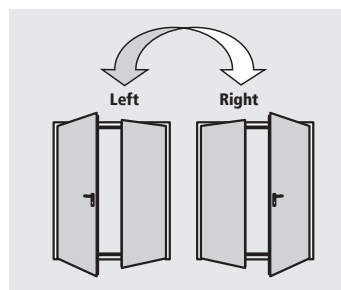
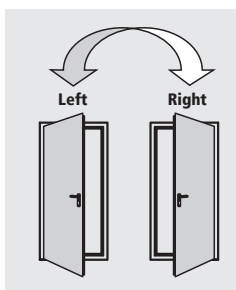

\*except in combination with certain optional accessories



One-leaved doors



Two-leaved doors

#### NOTE

The colors represented in the photos are not standard.

# Features

## REVER multipurpose doors

### STANDARD ELEMENTS

which comprise Rever multipurpose doors:

#### Door

- Made of "Sendzimir" processed hot-galvanized sheet metal, press folded
- Perimetral rebate on 4 sides
- Internal corrugated honeycomb fiber structure fixed firmly to the sheet metal
- Internal stiffeners for overhead door closer and panic bar
- Thickness of 40 mm

#### Doorframe

- Made of "Sendzimir" processed hot-galvanized sheet metal
- Grooves for rebate sealing
- Suitable for anchors for mortar fixing or expansion screws
- Detachable rebate for application on finished flooring
- Removable threshold for thresholdless installation
- Strike plates in PA6 black nylon for lock bolt
- Assembled doorframes for one-leaved doors
- Assembly required for two-leaved doorframes

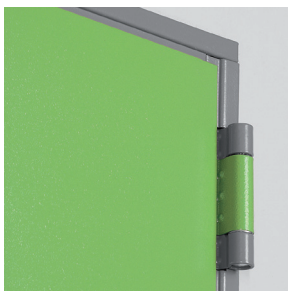
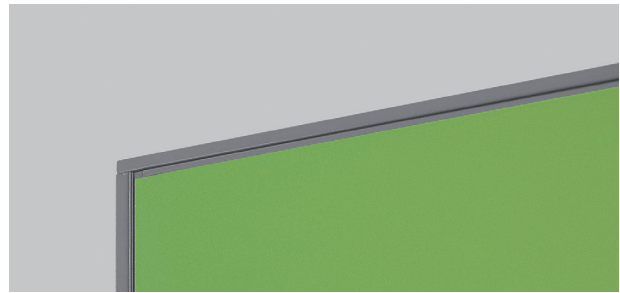

#### Hinges

- Nr. 2 three-wing hinges for each leaf

#### Locking mechanism

- Reversible locking mechanism with bolt and central latch
- Insert with patent key, Euro profile cylinder ready

#### Handle

- PA6 black nylon handle
- Fastener screws to pass
- Insert for patent-type key

#### Safety bolts

- Nr. 3 safety bolts applied on hinge side doorframe edge

#### NOTE

Cylinder and rebate sealing provided on request only.  
The handle requires assembly.

# Features

## REVER multipurpose doors



### INCLUDED ACCESSORIES

which comprise Rever multipurpose doors:

#### Safety lock

- Central latch for blocking and unblocking the passive leaf
- Lever control for unlocking vertical rods

#### Upper coupling system for the secondary leaf

- Vertical rod with steel point which inserts into the upper strike box
- Upper strike box in black PA6 nylon with steel roller

#### Lower coupling system for the secondary leaf

- Vertical rod with steel point which inserts into lower strike box
- Floor catch (floor-mounted bushing) in black nylon, for doors without threshold
- Floor catch in black nylon with a steel roller, for doors with threshold

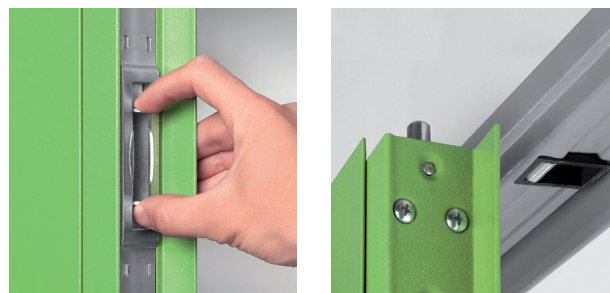

#### Standard paint - group 01:

leaf color NCS 4020-B50G

frame color NCS 5020-B50G

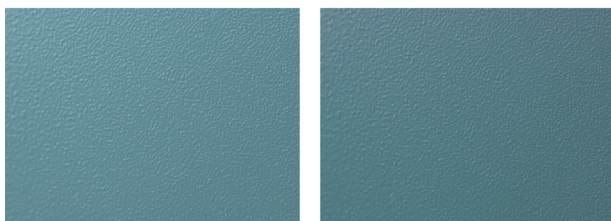

#### Finishing

- Standard painted with epoxy-polyester thermoset powders in a 180 degrees oven, orange skin, anti-scratch finishing
- Standard pastel turquoise color, lighter tone for the leaf (NCS4020-B50G), darker tone for the frame (NCS5020-B50G)

#### Standard packaging

- Single door wrapped into stretchable polyethylene (PE) film
- Assembled doorframes for one-leaved doors
- Assembly required for doorframes for two-leaved doors
- Palletized on wooden pallets

#### Pre-settings

- Each door is ready for the installation of a three-point SECUR lock
- The main lock and upper rod housing on the secondary leaf are ready for installation of the latching mechanism for panic bars

#### Door weight kg/m<sup>2</sup> of wall opening

1 leaf	15
2 leaves	14

#### NOTE

If the door ever needs to be repainted, follow the precise instructions on the "painting" page.

# Features

## REVER multipurpose doors

### OPTIONAL ACCESSORIES

A wide variety of accessories and surface finishes are available on request for maximum value enhancement of Rever doors to your own specific needs.

The proper accessories can help resolve:

#### Safety-related needs

- Doors for panic exits (see panic bars)
- Doors for emergency exits (see emergency exit handles)
- Three-point Rever SECUR lock

#### Installation and utilization needs

- Embracing or telescopic frames
- Frame extensions
- Drip steel-profile
- Kick and protection plates
- Windows
- Ventilating perforation
- Overhead frame panel
- Available with upper/lower crack enlargement

#### Access-related control issues

- Electrically-activated lock mechanisms
- Electric handle mechanisms
- Magnetic blocking mechanisms

#### Performance enhancing

- Rebate sealings
- Cylinders
- Door closers
- Special handles



#### NOTE

Details about optional accessories may be found in the following chapters of this brochure:

- Finishing
- Accessories for metal doors
- Panic bars

Right-opening doors are the default selection if opening direction is not specified.

#### Customized finishing

- Select paint colors from a wide variety of RAL tints
- NDD – Ninz Digital Decor, graphic images applied with special ink jets and protected by a transparent topcoat. Infinite varieties of customizable decorations in harmony with specific door settings
- Stainless steel handles
- Colored handles

#### Packaging for maximum protection

Sturdy wooden crates protect all doors and related accessories

- NDD decorated doors
- Construction sites
- Shipping abroad
- Special transport

The following optional accessories make Rever doors irreversible, requiring the indication of the door opening direction when the order is placed:

- SLASH panic bar
- Panic bar for secondary leaves
- Windows and ventilation grills
- MAC locks
- ELM/cisa and ELM/mt electric handle
- Special locks (016 tir- Stel 15)
- Overhead frame panels and prolonged frames
- Special doorframes (SPEED, SOLID, TESCOP)

# Specific optional accessories

## REVER multipurpose doors

### MULTIPURPOSE WINDOW

On request, the one- and two-leaved doors may be equipped with round or rectangular windows, with stratified 3 + 3 mm glass framed with a black rubber EPDM profile. The corners of rectangular windows are rounded (radius of approx. 100 mm).

#### Production limits

Window sizes are standard and the minimum border strips around the window may not be reduced.

#### Borders, window position

"Border measurement" refers to the distance from the edge of the window to the wall opening of the door.

#### Elevation for round windows

window size	FM H	position
Ø 300	minimum 1950	Y=1600
Ø 300	less than 1950	Y=FM H - 350
Ø 400	minimum 2000	Y=1600
Ø 400	less than 2000	Y=FM H - 400

#### Elevation for rectangular windows

window dimensions L x H	FM H	position
300 x 500	minimum 1950	Z=1500
300 x 500	less than 1950	Z=FM H - 450
400 x 700	minimum 2050	Z=1500
400 x 700	less than 2050	Z=FM H - 550

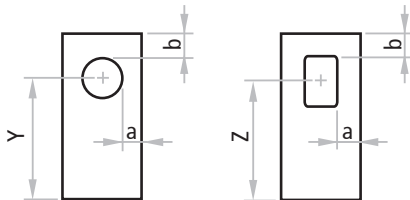

#### Round and rectangular window cross sections

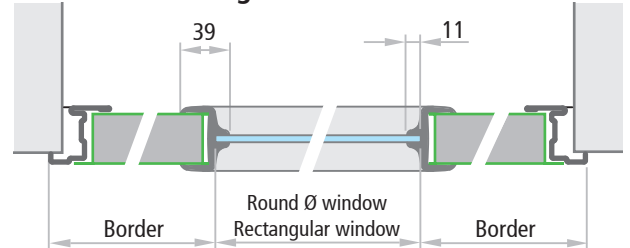

#### KIT window

The windows for Rever doors are also available as a KIT for later installation directly by the customer.

#### NOTE

The positions indicated above are standard. Different positions may be considered as long as they respect the minimum "a" and "b" border strips.

#### Window dimensions

Window dimensions	minimum border		FM L min. dimensions
	a	b	
	300 400	200 200	700 800
	300 400	200 200	L1 700 + L2 400 L1 800 + L2 400
	300 400	200 200	L1 700 + L2 700 L1 800 + L2 800
	300 x 500 400 x 700	200 200	700 800
	300 x 500 400 x 700	200 200	L1 700 + L2 400 L1 800 + L2 400
	300 x 500 400 x 700	200 200	L1 700 + L2 700 L1 800 + L2 800



# Specific optional accessories

## REVER multipurpose doors



REVER multipurpose

### SPECIAL ‚SPEED‘ DOORFRAME FOR REVER DOORS

SPEED on three sides embracing doorframe with 45 deg. joints, made of 1,25 mm thick galvanized „Sendzimir“ processed sheet metal, assembly required. For installation onto finished walls using 6 integrated clamps and two adjustable spacers with plugs or screws. Includes rebate sealing and RAL painting with thermoset epoxy-polyester powders. Minimum 75mm wall thickness, 55/70 frames.

Order measurements	required wall opening	doorframe opening
FM L (width)	FM L + 20	FM L - 64
FM H (height)	FM H + 10	FM H - 34

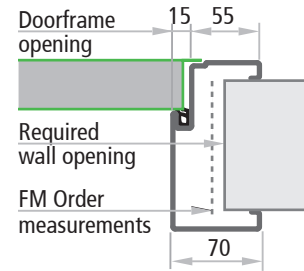
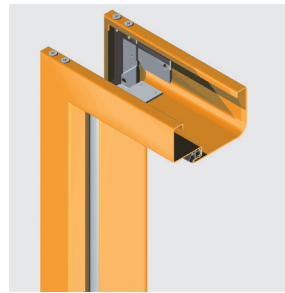

### SPECIAL ‚SOLID‘ DOORFRAME FOR REVER DOORS

SOLID on three sides embracing doorframe with 45 deg. joints, made of 1,25 mm thick galvanized „Sendzimir“ processed sheet metal, assembly required. For installation with anchors for mortar fixing or with iron bank to fix with plugs or screw on, including removable threshold spacer, sealing and RAL painting with thermoset epoxy-polyester powders. Minimum 50mm wall thickness, 45/45 frames.

Order measurements	required wall opening	doorframe opening
FM L (width)	FM L + 40	FM L - 64
FM H (height)	FM H + 20	FM H - 34

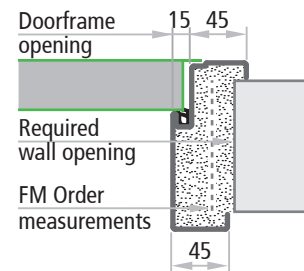
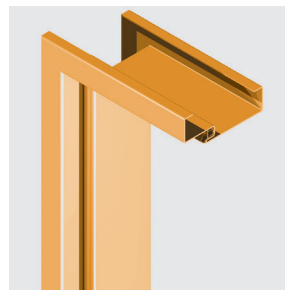

### SPECIAL ‚TESCOP‘ DOORFRAME FOR REVER DOORS

Two-pieced TESCOP on three sides embracing doorframe with 45 deg. joints, made of 1,25 mm thick galvanized „Sendzimir“ processed sheet metal, assembly required. To be fixed to finished wall with screws, including removable threshold spacer, sealing and RAL painting with thermoset epoxy-polyester powders. Minimum 70mm wall thickness, adjustment range of +25mm, frames 55/70.

Order measurements	required wall opening	doorframe opening
FM L (width)	FM L + 20	FM L - 64
FM H (height)	FM H + 10	FM H - 34

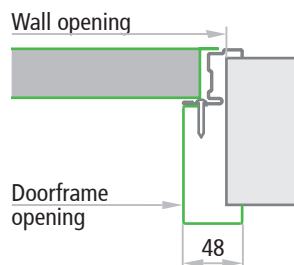
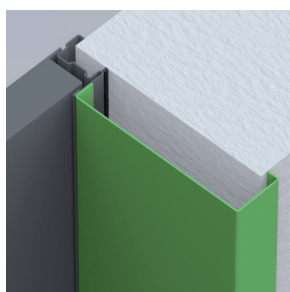
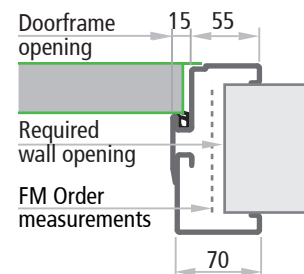
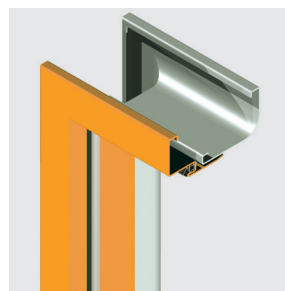

### IM21 FRAME EXTENSION FOR REVER DOORS

Frame extension to be screwed to the Rever doorframe acting as a wall cladding. Made of „Sendzimir“ processed hot-galvanized sheet metal painted the same color as the doorframe with epoxy-polyester powders. Profile on three sides, upper corners with 45 degree joint. To mount the frame extension, fixing holes need to be drilled into doorframe on site. Combine with sealing to conceal the screw heads.

Minimum 60mm wall thickness.

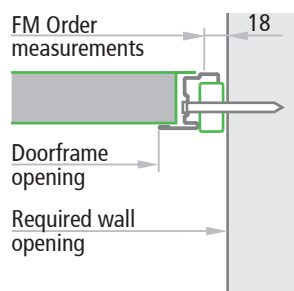
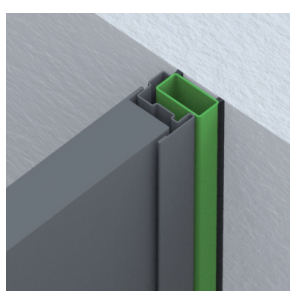

### INSTALLATION „IN THE REVEAL“ WITH BLOCK FRAME

On request additional block profiles for one- and two-leaved multipurpose Rever doors. Consists of 3 sections of hollow 40x20x1,5mm metal profiles painted the same color as the doorframe using thermoset epoxy-polyester powders. Installation with screws and plugs (screws and plugs not included).

Required wall opening = FM L + 36, FM H + 18

# Specific optional accessories

## REVER multipurpose doors

### VENTILATION GRATE

Ventilation grate made of either black or white PVC, 482 x 99 mm (air passage approx. 150 cm<sup>2</sup>). The opening direction of the door needs to be specified.

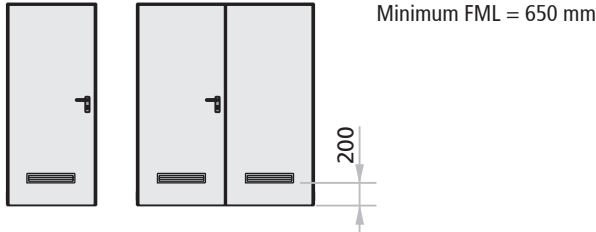

### VENTILATING PERFORATIONS

Ventilating perforation for one- and two-leaved Rever doors and for the active leaf of two-leaved doors; made by perforating the illustrated pattern into the sheet metal, air passage of approx. 200 cm<sup>2</sup> per leaf. Rever doors with ventilating perforations remain reversible.

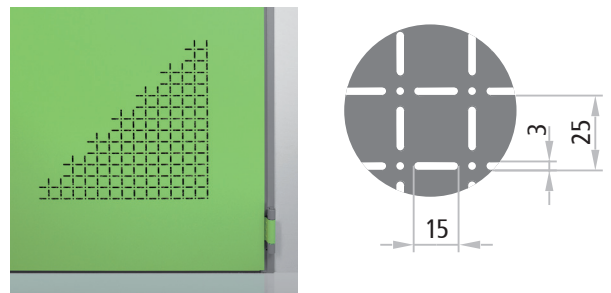
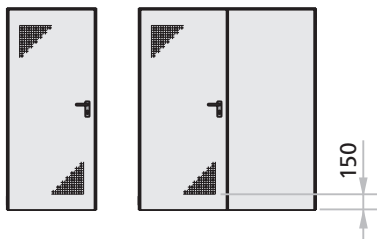

#### NOTE

Ventilating perforations are only provided on the main leaf of two-leaved doors.

### OVERHEAD FRAME PANEL WITH VENTILATING PERFORATION

A prolonged frame with a galvanized, pre-drilled 12/10 mm thick piece of sheet metal to serve as the overhead frame panel with ventilating perforation, which also functions as the upper rebate for the leaf. Painted the same color as the leaf using thermoset epoxy-polyester powders. Also available for Speed, Solid and Tescop door-frames. Panel, leaf and frame require on-site assembly.

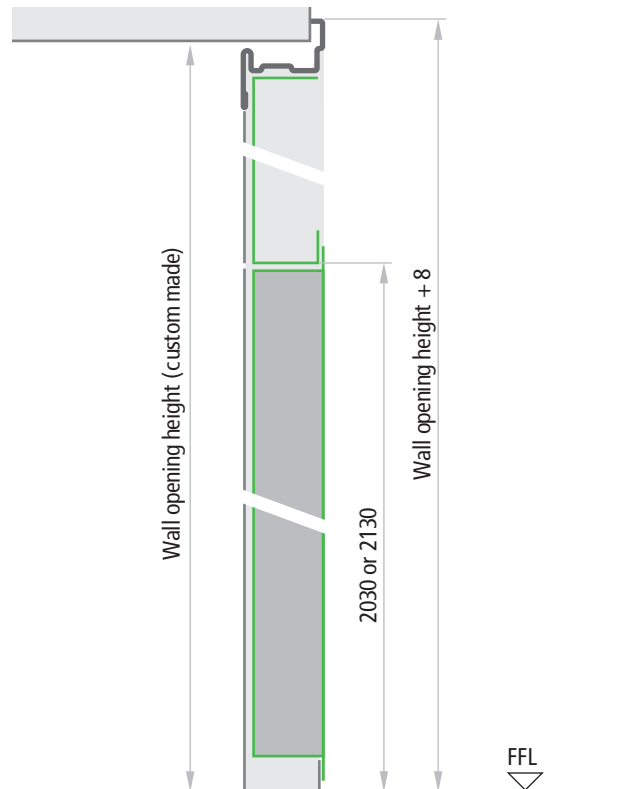
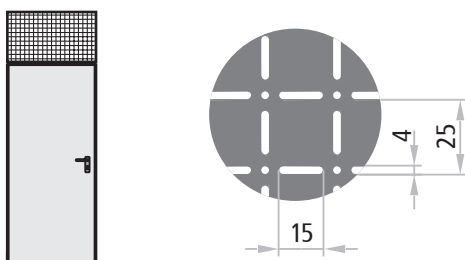
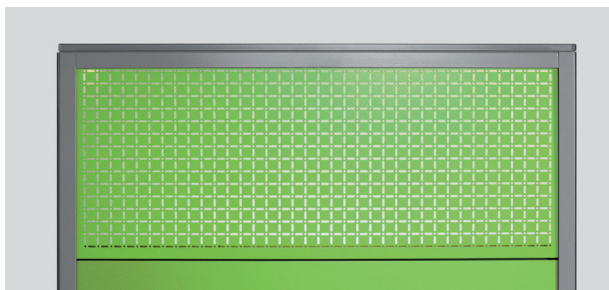

# Specific optional accessories

## REVER multipurpose doors



REVER multipurpose

### DOOR WITH EXTENDED FRAME

Frame extends beyond the door leaf to create a 100 mm crack either below or both above and below. When using the standard Rever door leaf and an extended frame, the positioning of the handle is higher as a consequence.

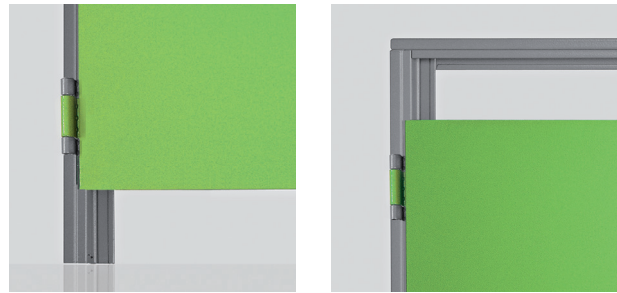
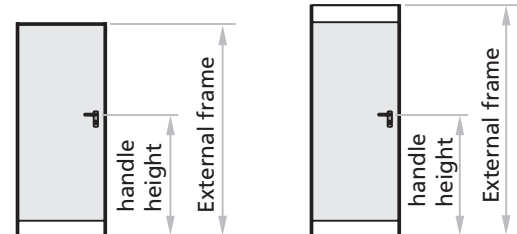

	Handle height	external frame	required wall opening
crack below	$FM H / 2 + 150$	$FM H + 108$	$FM H + 100$
crack below and above	$FM H / 2 + 150$	$FM H + 208$	$FM H + 200$

### THREE-POINT SECUR LOCK FOR REVER DOOR

The SECUR version of Rever provides a more reliable door closure. Activating the lock with a key blocks the leaf in the frame at three points: in the center with the latch bolt, above with the rod that inserts into the upper strike box and below with the rod that inserts into the lower strike box.

Also available as a KIT for on-site installation. SECUR Rever doors remain reversible.



upper strike box

lower strike box (bushing)

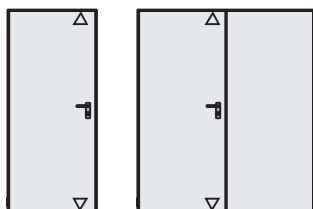

▷ Additional locking points

#### NOTE

Not available in the anti panic version.

### FF REBATE SEALING

FF sealing in black extruded profile to be pressed into the dedicated groove of the perimetral frame.

FF sealing in black extruded profile self-adhesive for application to the central joint of two-leaved doors.

#### NOTE

Upon request sealing supplied for single doors to be cut and mounted on site.

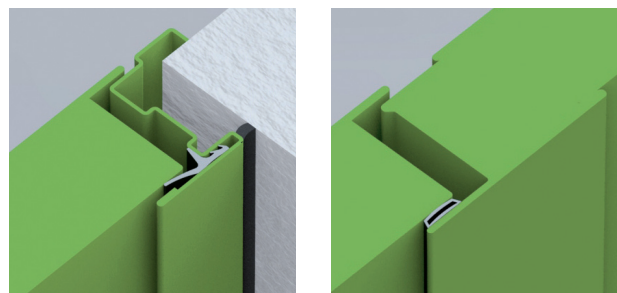

perimetral frame

central joint for two-leaved doors

# Door cross sections - Measurements

REVER multipurpose doors



REVER multipurpose

## One-leaved doors Horizontal cross section

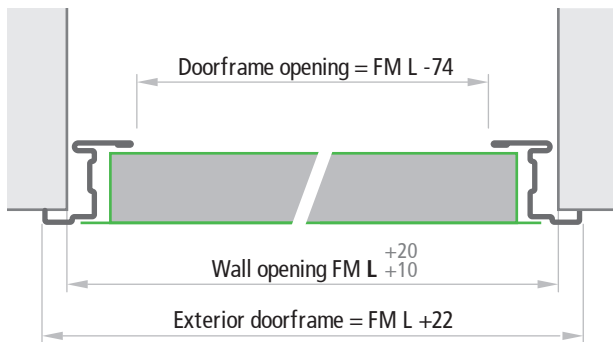

## Doors without lower threshold Vertical cross section

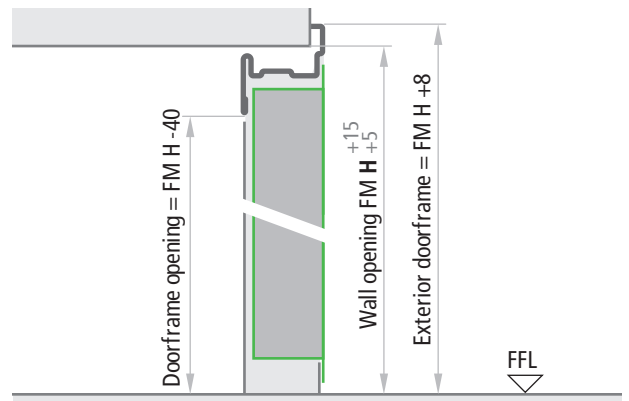

## Doors with internal and external lower threshold Vertical cross section

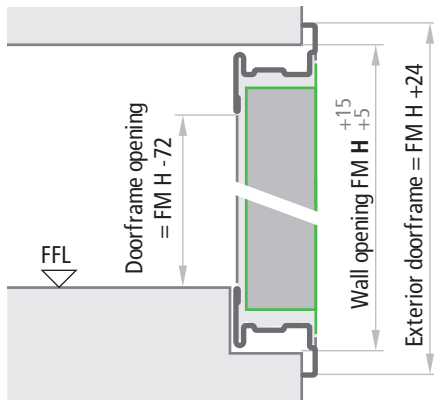

## Doors with internal lower threshold Vertical cross section

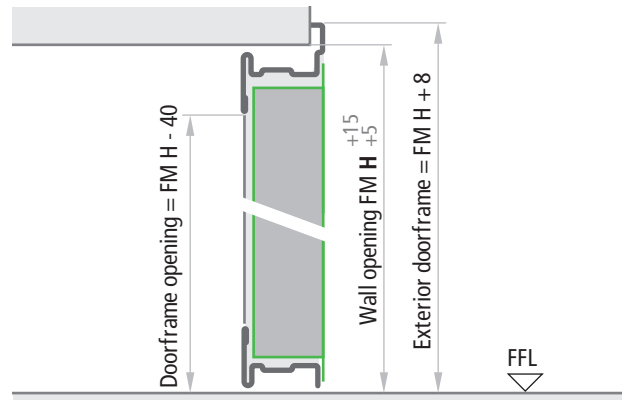

## Two-leaved doors Horizontal cross section

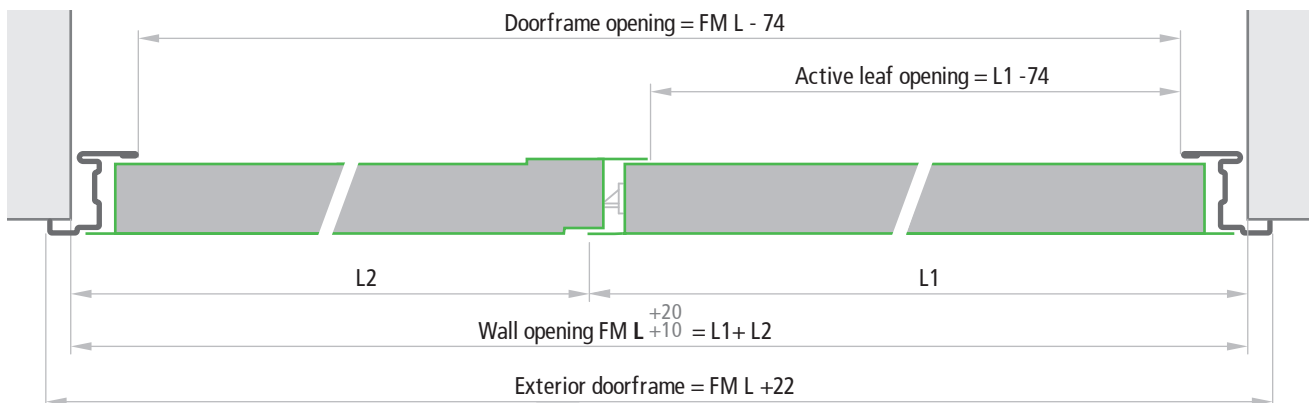

### Leaf thickness

MULTIPURPOSE	40 mm
--------------	-------

### NOTE

The tolerances  $FM L +20$ ,  $FM H +15$  of the indicated measurements make it easier to fill the gap between the wall and the doorframe with cement mortar.

For dry wall installation, the holes must be precise and greater tolerance ranges should not be employed.

FFL = Finished Floor Level

## INSTALLATION WITH ANCHORS FOR MORTAR FIXING

For mortar fixing, appropriate cuts will need to be created in the walls (section 80 x 160 mm) or the anchors should be fixed with expansion screws. The anchors should be bent and blocked inside the wall. For best mechanical hold, the space between the doorframe and the masonry should always be filled with concrete mortar or polyurethane foam.



## INSTALLATION FOR EXPANSION SCREWS FIXING

For the installation with expansion screws, the anchors serve as spacers and should not be bent. Using Würth type art. 0910436112 plugs or similar (supplied at the customer's expense), installation is done with expansion screws into the pre-drilled holes present on the frame. For the best mechanical hold, the space between the doorframe and the masonry should always be filled with concrete mortar or polyurethane foam.

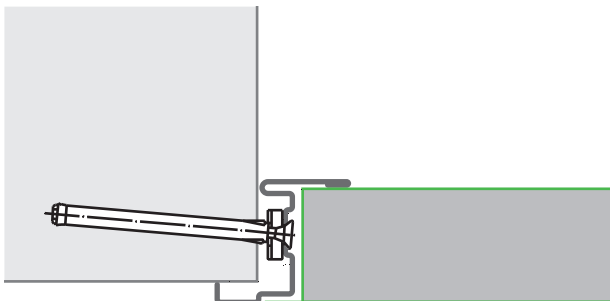

## ANCHOR POSITIONING

### One-leaved doors

Right opening and Left opening

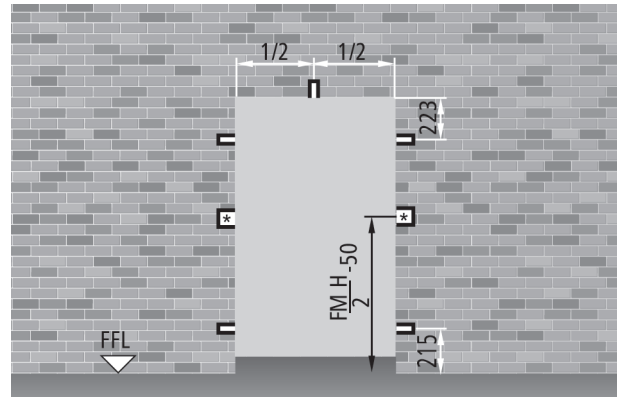

### Two-leaved doors

Right opening

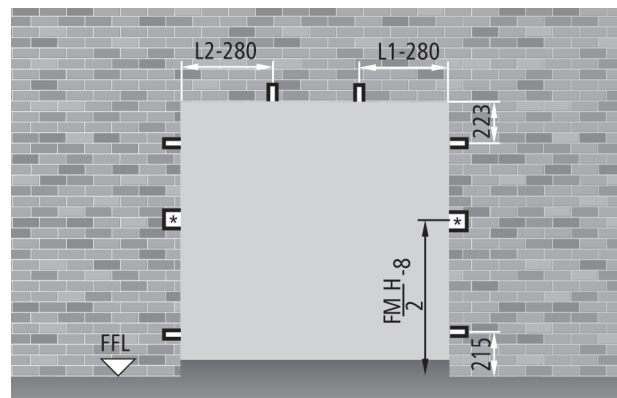

Left opening

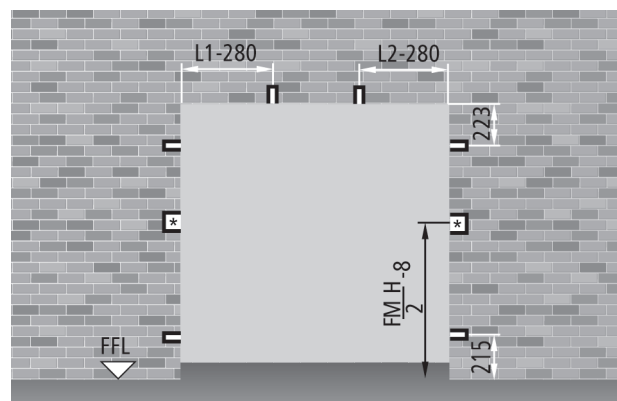

(\*) For proper installation, the cuts for the anchors should be 200 x 160 mm in size.

## ORDER MEASUREMENTS

### Wall Opening

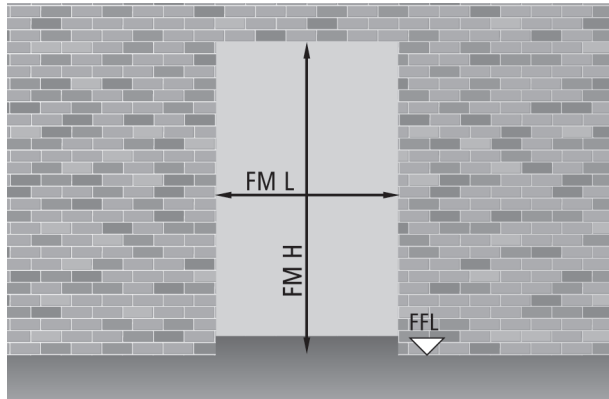

### Doorframe opening

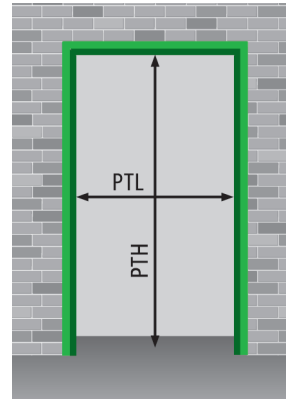

#### One-leaved doors

$$PTL = FML - 74$$

$$PTH = FMH - 40$$

#### Two-leaved doors

$$PTL = FML - 74$$

$$PTH = FMH - 40$$

### One-leaved door FM L x FM H

#### standard dimensions

700	x	2050 / 2150
800	x	2050 / 2150
900	x	2050 / 2150
1000	x	2050 / 2150
1100	x	2050 / 2150
1350	x	2050 / 2150

#### semi-standard dimensions

from 500 to 1345	x	2050 / 2150
------------------	---	-------------

#### non-standard dimensions

from 500 to 1350	x	from 1780 to 2150
------------------	---	-------------------

### PT L x PT H

#### doorframe opening

626	x	2010 / 2110
726	x	2010 / 2110
826	x	2010 / 2110
926	x	2010 / 2110
1026	x	2010 / 2110
1276	x	2010 / 2110

from 526 to 1271	x	2010 / 2110
------------------	---	-------------

from 526 to 1276	x	from 1740 to 2110
------------------	---	-------------------

### Two-leaved doors FM L (L1+L2) x FM H

#### standard dimensions

1200	( 800 + 400)	x	2050 / 2150
1300	( 900 + 400)	x	2050 / 2150
1400	( 700 + 700)	x	2050 / 2150
1600	( 800 + 800)	x	2050 / 2150
1800	( 900 + 900)	x	2050 / 2150
2000	(1000 + 1000)	x	2050 / 2150

#### semi-standard dimensions

from 900 (500+400) to 2000 (1000+1000)	x	2050 / 2150
--	---	-------------

#### non-standard dimensions

from 900 (500+400) to 2000 (1000+1000)	x	from 1780 to 2150
--	---	-------------------

### PT L x PT H

#### doorframe opening

1126	x	2010 / 2110
1226	x	2010 / 2110
1326	x	2010 / 2110
1526	x	2010 / 2110
1726	x	2010 / 2110
1926	x	2010 / 2110

from 826 to 1926	x	2010 / 2110
------------------	---	-------------

from 826 to 1926	x	1740 / 2110
------------------	---	-------------

### NOTE

Buyers should be aware that pursuant to and in accordance with Legislative Decree dd. 19.09.1994 Nr. 626, resp. of Legislative Decree dd. 19.03.1996 Nr. 242, all doors used for emergency exits or routes must have a minimum height of 2000 mm (= nominal wall opening

2040 mm). Unless specified otherwise by the customer, two-leaved standard, semi-standard and customized doors are supplied with a right pull opening direction.

## OPENING MEASUREMENTS AND ENCUMBRANCE WITH 90 DEGREE OPENING

### One-leaved doors with panic bar

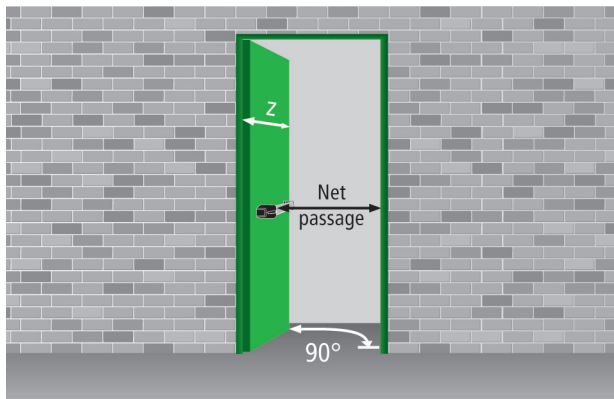

### Two-leaved doors with panic bars

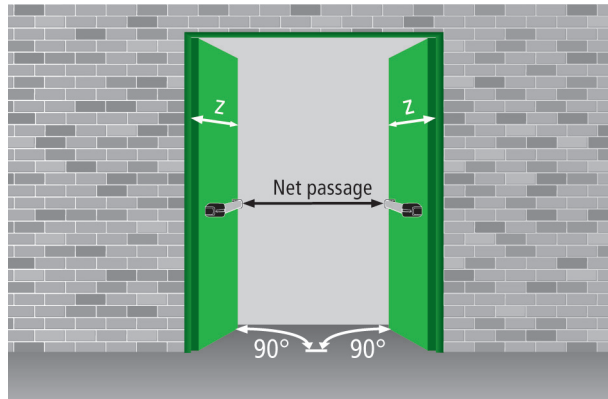

### Net passage calculation

panic bar type	protrusion	one-leaved door	two-leaved door
EXUS	125	FML - 209	FML - 344
TWIST	100	FML - 184	FML - 294
SLASH	75	FML - 159	FML - 244
TOUCHBAR	74	FML - 158	FML - 242
z = leaf protrusion relative to the wall		FML + 11	L1 + 11 L2 + 56

## ENCUMBRANCE WITH 180 DEGREE OPENING - HANDLE HEIGHT

### One-leaved door

$$x = FML - 4$$

$$h \text{ handle} = FMH/2 + 50$$

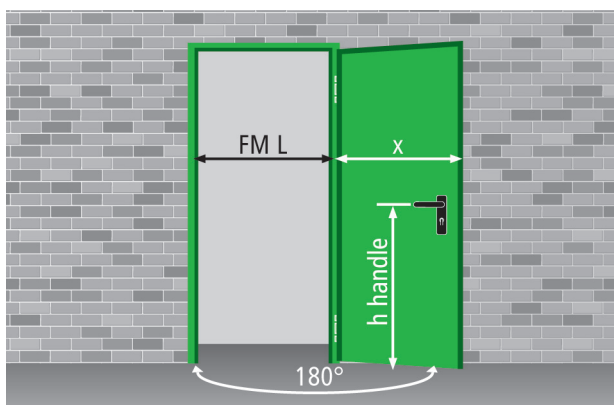

### Two-leaved door

$$x = L1 - 4 \quad y = L2 + 42$$

$$h \text{ handle} = FMH/2 + 50$$

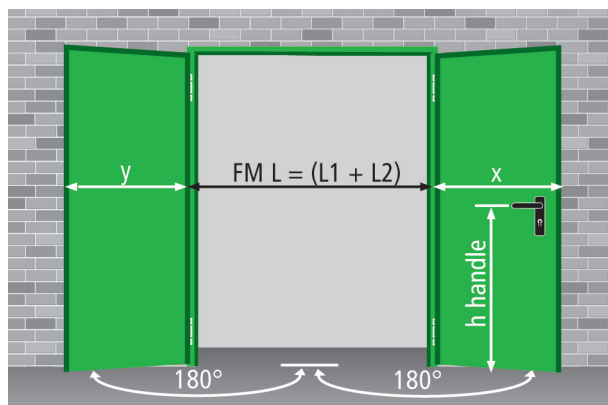

### NOTE

The 90 or 180 degree opening of the leaf could be compromised if handle or door closer protrusions come into contact with the wall.

### REVER - GENERAL NOTES

All rights reserved. No reproduction (partial or total) without prior authorization by Ninz. Ninz reserves the right to modify the product. Installation should be executed by qualified technicians.

Modifications may only be made as indicated in the installation instructions. Original NINZ replacement parts must be used for all repair work.

## Painting

This standard door is painted with thermoset powders, anti-scratch orange skin and semi-glossy finish (except for certain colors). The paint is particularly resistant and offers a pleasant finish for interior applications. Choose from a wide range of RAL colors.



### STANDARD COLORS WITH NO PRICE SUPPLEMENT

Paint for interior use (group 01) with turquoise pastel colored epoxy-polyester powders - lighter tone for the leaf (NCS4020-B50G) and darker for the frame (NCS5020-B50G). The tonalities of the frame and the door leaf are represented on the photo to the right.

#### Standard paint - group 01:

leaf color NCS 4020-B50G

frame color NCS 5020-B50G

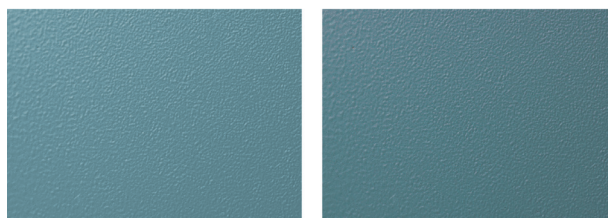

### SPECIAL COLORS WITH PRICE SUPPLEMENT

Paint for interior use (groups 02 and 03) available in a variety of RAL colors with epoxy-polyester powders. Doors must be protected from atmospheric agents. Sunlight fades the colors.

Distinct from other RAL tints, metallic tinted paints RAL 9006, RAL 9007 (group 3) and RAL 9006 E (group 04) present a finish with a wrinkled structure that requires pre-approval of a sample.

#### Group 02:

RAL 1013	RAL 1015	RAL 5010	RAL 5024	RAL 6000	RAL 7016	RAL 7024	RAL 7035
RAL 7038	RAL 8011	RAL 9001	RAL 9002	RAL 9010	RAL 9011	RAL 9016	RAL 9018

#### Group 03:

RAL 1001	RAL 1003	RAL 3000	RAL 3003	RAL 3020	RAL 5012	RAL 5015	RAL 6005
RAL 7001	RAL 7004	RAL 7011	RAL 7030	RAL 7032	RAL 7037	RAL 7040	RAL 7042
RAL 7047	RAL 8017	RAL 8019	RAL 9005	RAL 9006*	RAL 9007*		

\*requires pre-approval of a sample.



## SPECIAL COLORS FOR EXTERIOR USE WITH PRICE SUPPLEMENTS

Paint for exterior use (group 04) with polyester powders in various RAL tints.

Group 04:							
RAL	RAL	RAL	RAL	RAL	RAL	RAL	RAL
1013E	3000E	5010E	6005E	7016E	7024E	7035E	9002E
RAL	RAL	NCS	NCS				
9006E*	9010E	4020E	5020E				

\*requires pre-approval of a sample.

## SPECIAL COLORS BY REQUEST WITH PRICE SUPPLEMENTS

Paint available for interior and exterior use (group 05) with epoxy-polyester and polyester (respectively) powders in the requested RAL tints. Group 05 does not include special colors, such as metallic, mica, smooth or wrinkled texture and other sample tints like Pantone, NCS, etc.

Group 05:	
Colors by request only	

### Cleaning

Water and neutral soap are recommended for the regular cleaning of our products. Do not use common cleaning products (see detergents) and/or other solvents. We shall not be held responsible for any problems that arise if these guidelines are not respected.

### Retouching

On request, the Ninz company also provides touch-up paint (nitro/synthetic) in 0,25 or 1,00 kg cans in the necessary RAL tint.

### Re-painting

- For re-painting, use the following procedure:
- sand and carefully wipe away any dust from the surfaces
- apply a base layer of opaque 2-component epoxide - we recommend EPOX product Nr. 5203 beige 0059 (made by ALCEA, in Milan)
- repaint the surfaces with your choice of lacquers or paints.

### Protection

Since the doors have been designed for normal interior use, they should always be protected from atmospheric agents and direct sunlight. Exterior uses require paints that are specially designed for this kind of application (see groups 04, 05).

### WARNING!

Application to exterior doors requires for the adoption of various measures for preventing product degradation, such as:

1. The door should always be protected from bad weather. The door can be permanently damaged if water seeps inside the door leaf. Provide canopies or roofing to protect newly installed and existing products.
2. Avoid choosing darker colors when the doors will be exposed to direct sunlight. The sheet metal can heat up and cause warping of the door leaf that may compromise the functionality of the door itself.

An artifact of the printing process is that the colors depicted here may not correspond exactly to the colors of actual doors. Please see the RAL or NCS samples.



## DESCRIPTION

NDD - Ninz Digital Decor decorative painting. Graphic illustrations are applied directly to the flat surfaces of the door leaf after it has been painted with a base coat of polymerized powders. Painting with high-resolution digital print using special ink jets. The application of an additional layer of transparent coating ensures optimal protection of the decorative paint. Decorative NDD painting is available for the entire range of one- and two-leaved Rever, Univer and Proget doors.

**NDD® - Ninz Digital Decor introduces style and design to metal door products. Ninz doors can be directly printed with either your company's logo or designs, materials and symbols selected from a wide variety of NDD®, or also with your preferred artwork or customized images. NDD® introduces innovations to doors as an architectural entity; introducing NDD® can create added value on socio-cultural, economic and emotional dimensions.**

awarded with the  
**security&safety**  
award

**The [www.ninz.it](http://www.ninz.it) website illustrates an infinity of continuously updated decorations that have been categorized into eight groups for rapid review. The groups are listed on the next page.**

### Laboratory testing executed on NDD® samples

### result

500 h exposure test in salt fog	good performance, no sign of deterioration encountered
500 h humidity resistance test	good performance, no deterioration or loss of surface shine
500 h UVA radiation resistance test	good performance, no deterioration or loss of surface shine
Abrasion resistance test after 1000 cycles	the decoration was unaltered
Solvent resistance test	good performance, no deterioration in the decoration or the background paint

**ARTLINE** This group includes a wide selection of famous artworks drawn from ancient history up to the present day. These extraordinary designs endow the environment with a special atmosphere as an expression of style.



**WOOD** This set includes an endless variety of realistic imitations of classic, exotic, special and colored types of wood.



**FANTASY** NDD is a data bank of exclusive NINZ images and creations.



**STONES** This selection includes an endless variety of realistic imitations of marbles, granites and other stones.



**REFINEMENTS** Contains an infinite number of NDD decorations and textures created on customer request and available and useable for a diverse variety of applications.



**PUBLICITY** Transforms Ninz doors into a publicity tool for the company and its products. Printing of the logo integrates the door into the company image. A variety of actual applications are reported here.



**PHOTOGRAPHS** This group contains original photos of country sides, objects, animals, environments, etc., with the appropriate foto resolution.



**SYMBOLS** Given the particular importance of this group, a special department has been created for workplace safety symbols, room description/labeling symbols, the simple numbering of rooms, etc.



## DECORATIONS FROM OUR DATABASE

Doors with decorative NDD painting are supplied with:

- doorframes in the proposed color
- door leaf rebate in the base color of the leaf itself
- hinges in the frame color
- accessories of the type and finishing according to the Ninz door price lists and brochures
- decoration covering the window frame and/or the central upright, require that these are covered with NDD decorated sheet metal

## SPECIAL DECORATIONS

New codes and pricing are required for customized decorations and decorations that employ colors not listed in this brochure. In such cases, customers may also be asked to indicate where logos and symbols should be positioned on the door leaf, via the following forms of support:

- **PC-GENERATED FILE** (logos, symbols, designs, etc.) in specialized "Illustrator" or "Freehand" format. Submit the file by e-mail or on a CD/DVD-ROM.
- **DIAPOSITIVE** with a 36 mm or 6 x 6 image of the picture uploaded to a PC using a scanner (professional scanner required). Submit the file (TIF, PDF or JPG format) in **maximum resolution** on CD/DVD-ROM.
- **PHOTOGRAPHIC IMAGE** made with a digital camera. Submit the file (TIF, PDF or JPG format) in **maximum resolution** on CD/DVD-ROM.

## PROTECTION FOR EXTERIORS

The exterior installation of NDD doors requires specific treatments for preventing the decorations from deteriorating over time. The cost supplement covers all door leaf surfaces except for the leaf rebate.

## WOODEN CRATE PACKAGING



The particularity and prestige of NDD decorations requires a special protection of the doors by packaging them in special wooden crates with an additional layer of external nylon wrapping. At the time of ordering, therefore, the additional cost for the wooden crate must be taken into consideration. Customers who opt for standard packaging on pallets must assume full responsibility in case of damage to the product.



# MORE THAN FIREDOORS

## EXAMPLE APPLICATIONS IN TYPICAL SURROUNDINGS

Airports - Train stations

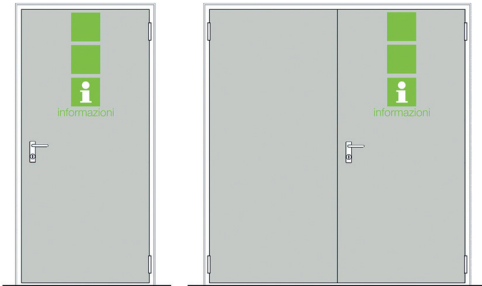

Museums – Historical buildings



Commercial businesses



Hospitals – Nursing homes

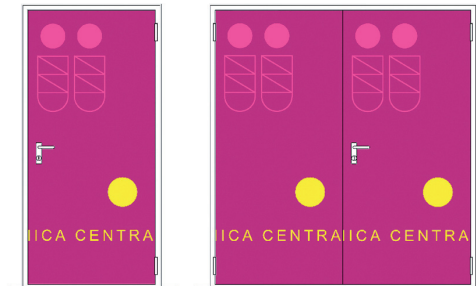

Sport centers – Stadiums



Parking lots

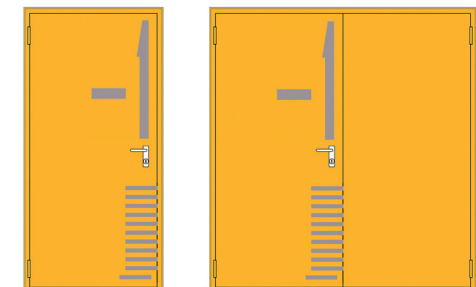

Logistic centers

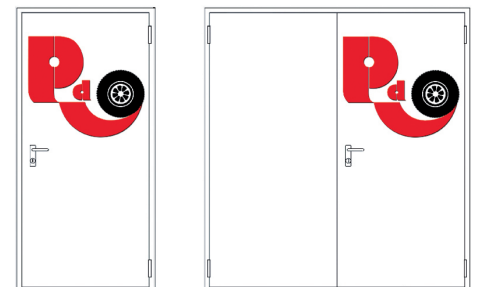

Schools - Universities

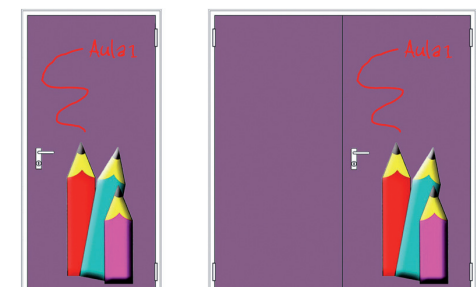

Hotels – Residences



Offices



# Black Nylon handles

Standard for REVER - UNIVER - PROGET doors



## DOOR HANDLES

By default Rever, Univer and Proget doors include safety levers coupled with long backplates with cylinder holes. Each handle set includes a patent key insert, a 9 x 9 square spindle, fastener screws and spacers.

M1 handles are fire rated consisting of a metal core inside the lever and a galvanized steel cover plate to protect the cylinder hole.

The M1 handles have been certified in accordance with DIN 18273:1997-12.

### M1 HANDLE

Fire rated Univer and Proget doors are equipped by default with M1-type handles.

The M1 handle package includes: a pair of black nylon lever with metal cores and galvanized steel installation plates, a pair of black nylon backplates with patent-type cylinder hole adaptable for installment of Euro profile cylinders, a 125 mm long 9 x 9 square spindle, fastener screws and spacers. The package includes also the hexagonal key for setting of the hinges and fastening of the spring screw.

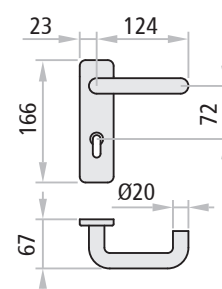

M1 NYLON 6 Handle

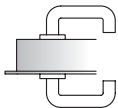
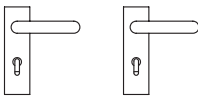
Version	description	functioning	use
M1 	 handle/handle combination with cylinder hole on both sides. To be combined with locks with an inter-axis distance of 72 mm (015)	door opening by handle or key from both sides	applications in which both door opening directions are accessible without key

### M1R HANDLE

The multi-purpose Univer and Proget doors are equipped with M1R-type handles.

The M1R handle package includes: a pair of black nylon lever handles, a pair of black nylon backplates with patent-type cylinder holes adaptable for installment of Euro profile cylinders, a 125 mm long 9 x 9 square spindle, fastener screws and spacers.

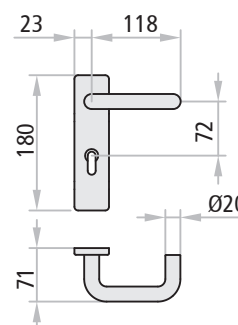
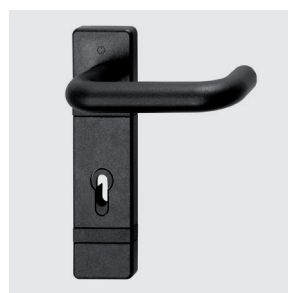

M1.R NYLON 6 Handle

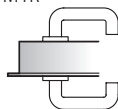
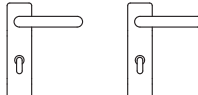
Version	description	functioning	use
M1R 	 handle/handle combination with cylinder hole on both sides. To be combined with locks with an inter-axis distance of 72 mm (015)	door opening by handle or key from both sides	applications in which both door opening directions are accessible without key

#### NOTE

Handles are considered to be accessories and are not pre-assembled. Cylinders need to be ordered separately (except for Secur handles).

# Special black Nylon handles

For locks with an inter-axis distance of 72 mm

## SPECIAL HANDLES

Rever, Univer and Proget doors may be equipped on request with handles with special functions other than those provided by standard handles.

Versions			description	functioning	use	
M2				handle/ doorknob combination with cylinder hole on both sides. To be combined with locks with an inter-axis distance of 72 mm (015)	the doorknob side requires the key for opening	applications in which only one of the door opening directions is accessible with a key
M4				doorknob/ doorknob combination with cylinder hole on both sides For combination with locks with an inter-axis distance of 72 mm (015)	both sides require the key for opening. The doorknobs serve for pushing or pulling the door	applications in which both door opening directions are accessible by key only
M5				plate/plate combination with cylinder hole on both sides. For combination with locks with an inter-axis distance of 72 mm (015)	both sides require the key for opening	applications in technical rooms with doors that usually remain closed and require keys for opening
M9				doorknob/plate combination with cylinder hole on both sides. For combination with locks with an inter-axis distance of 72 mm (015)	both sides require the key for opening The doorknob serves for pulling the door	applications in which both door opening directions are accessible by key only
M11				handle/ handle combination without cylinder hole. For combination with locks with an inter-axis distance of 72 mm (015)	opening is possible at any time using the handle	applications in which the door never needs to be locked
M20				handle/handle and doorknob combination for interior closure. For combination with locks with star-shaped spindles only (Stel 15)	closure using thumbturn latch from inside. Emergency opening from outside with screwdriver	typical closure for bathroom doors

### NOTE

Models M2, M4, M5, M9 and M20 cannot be combined with the three-point locking mechanism.  
Handles are considered to be accessories and assembly is required.  
Cylinders need to be ordered separately.

# Colored handles - Stainless steel handles

For locks with an inter-axis distance of 72 mm



ACCESSORIES  
doors

## COLORED DOOR HANDLES

On request, painted resin handles can be provided which match or provide better contrast with the base color of the door.

M1C and M2C handles are fire rated like the M1 handle, and have also been certified in accordance with DIN 18273:1997-12.

The M1C and M2C handles package consist of: one pair of lever handles (M1C) or the handle/ doorknob combination (M2C) made of polypropylene (PP) with a metal core and galvanized steel installation plate, a pair of polypropylene (PP) backplates with a Euro profile cylinder hole, a 125 mm long 9 x 9 square spindle, fastener screws and spacers.



M1C colored RAL1023

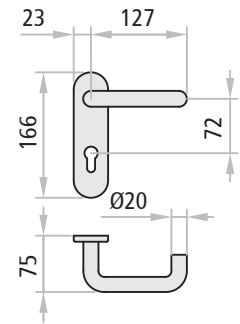

**Colors available:**

RAL 1023	RAL 7016	RAL 7035	RAL 9006*	RAL 9010

\*light aluminum

Versions	description	functioning	use
<p>M1C</p>	<p>handle/handle combination with cylinder hole on both sides. For combination with locks with an inter-axis distance of 72 mm (015)</p>	<p>door opening by handle or key from both sides</p>	<p>applications in which both door opening directions are accessible without a key</p>
<p>M2C</p>	<p>handle/doorknob combination with cylinder hole on both sides. For combination with locks with an inter-axis distance of 72 mm (015)</p>	<p>the doorknob side requires the key for opening</p>	<p>applications in which only one of the door opening directions works with a key</p>

## STAINLESS STEEL DOOR HANDLES

On request, satin-finished stainless steel AISI 304 levers and backplates can be provided which endow the product with a higher quality while at the same time ensuring optimal corrosion resistance and a noteworthy robustness of the entire set.

In addition, M1X and M2X handles are equipped with a return spring that maintains perfect alignment with the geometry of the door.

They are mounted on a galvanized steel mechanism and are supplied with a 125 mm long 9 x 9 square spindle, fastener screws and spacers.



M1 INOX handle

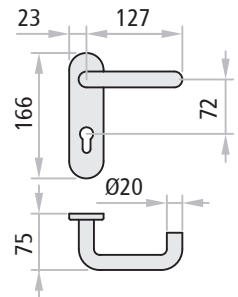

Versions	description	functioning	use
<p>M1X</p>	<p>handle/handle combination with cylinder hole on both sides. For combination with locks with an inter-axis distance of 72 mm (015)</p>	<p>door opening by handle or key from both sides</p>	<p>applications in which both door opening directions are accessible without a key</p>
<p>M2X</p>	<p>handle/doorknob combination with cylinder hole on both sides. For combination with locks with an inter-axis distance of 72 mm (015)</p>	<p>the doorknob side requires the key for opening</p>	<p>sostituire con „applications in which only one of the door opening directions works with a key</p>

**NOTE**

The M2C and M2X models are not combinable with the 3 point locking mechanism. Handles are considered as accessories and require assembly. Cylinders need to be ordered separately.



## CYLINDERS

On request Rever, Univer and Proget doors with standard locks (Std 015) or three-point locking mechanisms (3vie PRO) may be supplied with a Euro profile cylinder with three keys.

They may also be provided in unique coding or group coded versions, or in combination with unique or group mastering.

### Cylinders to pass

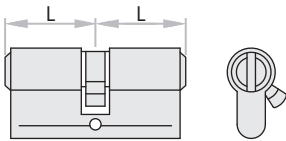

Double nickel-plated cylinder equipped with 3 keys

#### Versions available

- standard cylinder
- single coded cylinder
- group coded cylinder
- sample key coded cylinder
- single mastered cylinder
- group mastered cylinder



Lengths available	for door leaf thickness
40/40	60 mm
35/35	50 mm
30/30	40 mm

### ATTENTION

It is important to specify MAC lock combinations in the order.

### Cylinders to pass for thumbturn latch

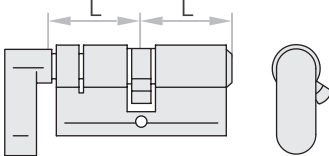

Double nickel-plated cylinder with chrome-plated thumbturn latch equipped with 3 keys

#### Versions available

- standard cylinder with thumbturn latch
- mastered cylinder with thumbturn latch
- mastered and emergency cylinder with thumbturn latch



Lengths available	for door leaf thickness
40/40	60 mm
35/35	50 mm
30/30	40 mm

### NOTE

Cylinders are considered to be accessories and assembly is required. Cylinders to be combined with locks of NINZ doors must meet DIN 18254 standards. Main, master and/or emergency key (or keys) should be ordered separately - they are not included with the cylinder.

## CYLINDERS FOR COMBINATION WITH PANIC BARS AND EMERGENCY HANDLES

Standard panic bars and emergency handles are supplied with a Euro profile cylinder with three keys. Cylinders with single coding, grouped coding or in combination with single or grouped mastering.

### Cylinders not to pass

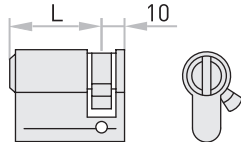

Half nickel-plated cylinder equipped with 3 keys



#### Versions available

standard half cylinder
single coded half cylinder
group coded half cylinder
sample key coded half cylinder
single mastered half cylinder
group mastered half cylinder

#### Lengths available

Lengths available	for door leaf thickness
40/10	60 mm
35/10	50 mm
30/10	40 mm

#### ATTENTION

It is important to specify MAC lock combinations in the order.

### Cylinders to pass in combination with EXUS DC panic bars

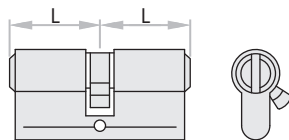

Double nickel-plated cylinder equipped with 3 keys.

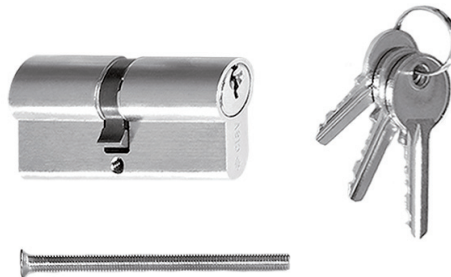

#### Versions available

standard cylinder
single coded cylinder
group coded cylinder
sample key coded cylinder
single mastered cylinder
group mastered cylinder

#### Lengths available

Lengths available	for door leaf thickness
45/40	60 mm
40/40	50 mm
35/35	40 mm

#### NOTE

Cylinders are considered to be accessories and assembly is required. Cylinders to be combined with the locks of NINZ doors must meet DIN 18254 standards. Main, master and/or emergency key (or keys) should be ordered separately - they are not included with the cylinder.

## CONFIGURED AS NEEDED!

NINZ asks its partners to specify the system in the form of a key plan which, when prepared with care, serves as a map for optimizing the required intervention times (from order to installation) while ensuring that the mastering system meets the specific needs being requested.

Here are a few of the configurations that are available:

### 1) Standard

Cylinders with different keys.

### 2) Single coded

Cylinders with the same keys.

### 3) Grouped coded

Cylinders from the same group are coded alike.

### 4) Main/master key systems

Grouped master key system in which each cylinder can be opened with its own key or with a master key that can open cylinders from one group but not others; a general master key can open all cylinders from all different groups. Standard cylinders closed from the interior with a thumb-turn latch cannot be opened with the main/master key.

### 5) Frictioned emergency

"Frictioned cylinder" means that the main or master key can only open doors that have not been closed from inside, while the same doors can still be opened with the emergency key.

### 6) Encrypted cylinder with sample key

Sample key coding allows for cylinders to be coded on the basis of a sample key supplied by the customer.

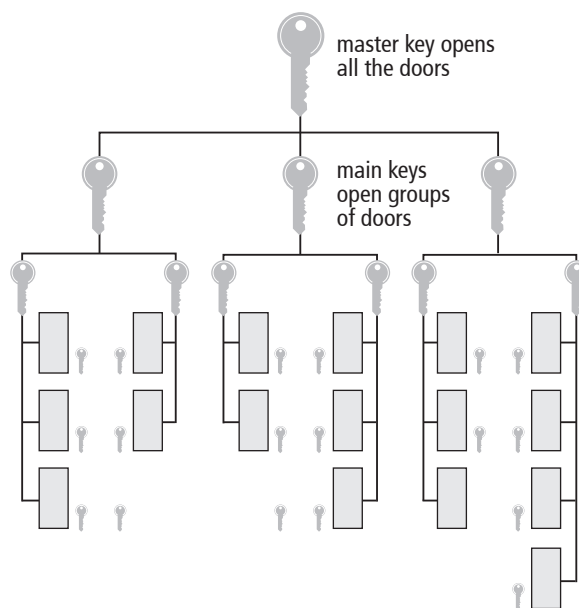

Key plan example for master key systems.

## KEYS

The order should specify the number of keys to be supplied with the mastered cylinders.

### Versions available

normal key	opens the single door only
main key	opens all doors from the same group
master key	opens all the doors that have grouped mastering
emergency key	opens all doors



Key

# Door closer

For REVER - UNIVER - PROGET doors



## DOOR CLOSER

The door closer regulates the closure of the door so that the door leaf returns properly to its final closed position after being released.

Regulation is influenced by closure force, speed and the final impact.

Although Univer and Proget doors are equipped with spring hinges for automatic closure, the installation of door closers is recommended for wide and/or heavy doors and/or in the presence of windows on the leaf.

The door closer product is addressed by EU directive 89/106/CEE, which means it is subject to **CE** marking.

### CP1 with scissor arm

**CE** marked in conformity with EN 1154.

Rever, Univer and Proget doors are available, on request, with an overhead CP1 door closer with a silver-colored scissor arm.

The CP1 can be used for fire rated doors and is classified for 180° closure with a force varying from 3 to 4.

Proget doors ordered with CP1 are provided with pre-drilled installation holes on the door leaf and the frame. Standard Rever, Univer and Proget doors include internal reinforcements for the CP1 application.

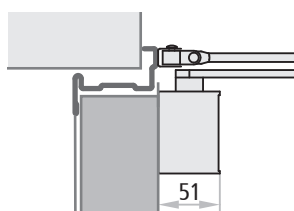

CP1 UNIVER

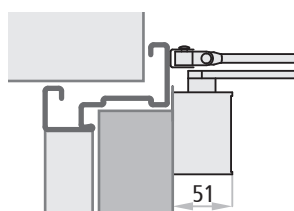

CP1 PROGET

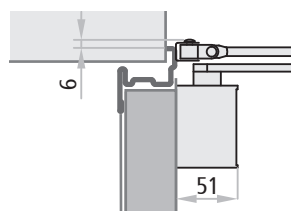

CP1 REVER

#### Optional colors:

RAL	RAL	RAL
dark bronze	9016	9005

#### NOTE

Arm protrusion = 290 mm



### CP2 with slide channel

**CE** marked in conformity with EN 1154.

On request Rever, Univer and Proget doors are available with an overhead CP2 door closer with slide channel. Relative to the CP1, the advantage of this system is the absence of a protruding arm.

The CP2 is suited for use on fire rated doors and has been classified for 180° closure with force level 4.

Proget doors ordered with CP2 are provided with pre-drilled installation holes on the door leaf and the frame. Standard Rever, Univer and Proget doors include internal reinforcements for the CP2 application.

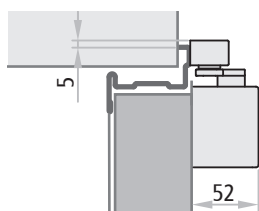

CP2 UNIVER

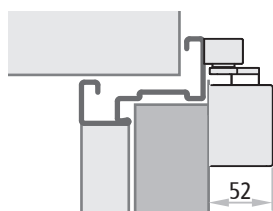

CP2 PROGET

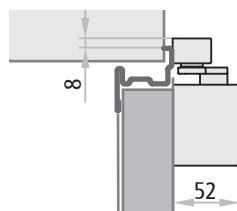

CP2 REVER

#### Optional colors:

RAL	RAL	RAL
dark bronze	9016	9005



## CP2-EMF with slide channel and electro-mechanical hold open device

CE marked in conformity with EN 1154 and EN 1155.  
 The CP2-EMF differs from the CP2 in that it has an electro-mechanical hold-open device that allows the door leaf to be locked at an angle ranging from 80° to 120°. During alarms or power outages, the hold-open device is unlocked and the door is closed by the door closer.  
 The CP2-EMF can be used on fire doors and has a maximum opening range of 120°, with a closing force set at 4.  
 Proget doors ordered with CP2-EMF are provided with pre-drilled installation holes on the door leaf and the frame.  
 Standard Univer doors include internal reinforcements for the CP2-EMF application.

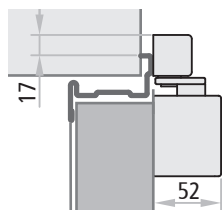
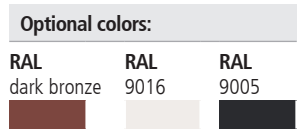

CP2 EMF UNIVER

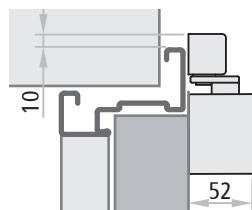

CP2 EMF PROGET

Model	maximum opening in the absence of obstacles			power supply	absorption	EC certification	standard
	one-leaved door	active leaf	secondary leaf				
CP1	180°	180°	180°	-	-	0432-BPR-0054	EN 1154
CP2	180°	180°	180°	-	-	0432-BPR-0051	EN 1154
CP2 EMF	120°	120°	120°	24 Vcc	58,3 mA	0432-BPR-0051 0432-BPR-0025	EN 1154 EN 1155

# Closing regulators

For UNIVER - PROGET fire doors

## CLOSING REGULATOR

Closing regulators administer the closure of two-leaved doors so that the secondary leaf is overlaid on the active leaf upon final closure. This is why it is mandatory to apply closing regulators to all two-leaved fire doors.

### There are two systems for applying it to the door:

- separated from the self-closing system of the spring hinge or the door closer
  - incorporated into the closure system of the door closer
- Closing regulators are addressed by EU directive 89/106/CEE, which means they are subject to **CE** marking.

### RC/STD

**CE** marked in conformity with EN 1158.

The RC/STD closing regulator device is distinct from the door closer and is a standard element of all Univer and Proget two-leaved fire doors.

In Proget doors the closing regulator is inserted into the upper horizontal groove of the frame, while in Univer doors it is supplied separately with an anchoring rod to be installed on site. In comparison with other regulators which are separate from the door closer, the advantage of the RC/STD regulator is that it is not visible when the door is closed.

The RC/STD regulator is suited for use on fire doors and is classified for forces ranging from 3 to 5.



UNIVER

PROGET

### RC2 system

**CE** marked in conformity with EN 1154 and EN 1158.

On request, two-leaved Univer and Proget doors are available with an RC2 regulator in place of the RC/STD.

The RC2 closing regulator system is incorporated into the door closer, and consists of 2 CP2 with force EN 4 with a slide channel and a regulator integrated in the upper sliding guide. The entire system is silver colored.

### The RC2 system presents clear advantages:

- no protruding door-closer arms
- regulator concealed in the upper guide (even when the door is open)
- controlled closure of both leaves

The RC2 regulator is suited for use on fire doors and is classified for both door closers with force EN4.

Minimum wall opening width of 1200 mm and minimum of 370 mm for the secondary leaf.

Proget doors ordered with RC2 are provided with pre-drilled holes for the installation of 2 CP2 door closers on the leaves and the slide channel on the frame. The installation holes in Univer doors need to be drilled on site for anchoring to the internal reinforcement of the leaves.

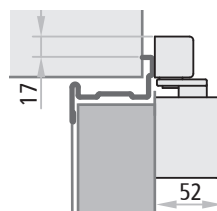

RC2 UNIVER

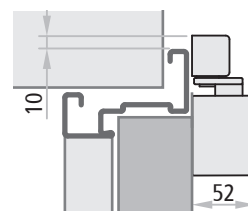

RC2 PROGET

Optional colors:

RAL	RAL	RAL
dark bronze	9016	9005

# Closing regulators

For UNIVER - PROGET fire doors



## RC2-EMF1 SYSTEM

CE marked in conformity with EN 1154, EN 1158 and EN 1155. The RC2-EMF1 system differs from the RC2 in that it has an electro-mechanical hold-open device that allows the door leaf to be locked at an angle ranging from approx. 80° to 130°. The active leaf is held open by the closing regulator system. During alarms or power outages, the hold-open system is unlocked and the door is closed by the door closer. The entire system is provided in the standard silver color.

### The RC2-EMF1 system presents multiple advantages:

- possibility of holding the leaves open in the desired position
- no visible magnets
- no protruding door closer arms
- regulator concealed in the upper guide (even when the door is open)
- controlled closure of both leaves

The RC2-EMF1 system is suited for use on fire rated doors and is classified for both door closers with force level EN4. Minimum wall opening width of 1200 mm and minimum of 370 mm for the secondary leaf.

Proget doors ordered with RC2-EMF1 are provided with pre-drilled installation holes on the door leaf and the frame. The Univer door series includes internal reinforcements for application of the two door closers.

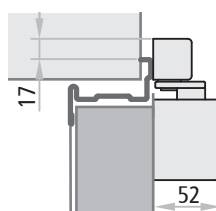

RC2-EMF1 UNIVER

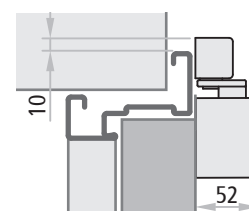

RC2-EMF1 PROGET

**Optional colors:**

<b>RAL</b> dark bronze	<b>RAL</b> 9016	<b>RAL</b> 9005

Model	maximum opening in the absence of obstacles		power supply	absorption	EC certification	standard
	active leaf	secondary leaf				
RC/STD	180°	180°	-	-	0425-ICIM-1153	EN 1158
RC2	180°	180°	-	-	0432-BPR-0051 0432-BPR-0026	EN 1154 EN 1158
RC2-EMF1	180°	130°	24 Vcc	58,3 mA	0432-BPR-0051 0432-BPR-0025 0432-BPR-0026	EN 1154 EN 1155 EN 1158

# Door sweep - Protection plates

For UNIVER - PROGET doors



## AUTOMATIC DOOR SWEEP

On request, Univer and Proget doors are available with an automatic door sweep to prevent air drafts from entering through the crack between the leaf and the floor. It complements the FF sealing applied to the frame to provide better acoustic insulation and better air sealing for the door.

It is applied on the push side by using screws to attach it directly to the sheet metal of the door, after which the mechanism is completely covered with an anodized aluminum profile. On request, it can also be provided in the same color as the door leaf.

It is applied on site following door installation so that it can be adjusted to the actual leaf height.

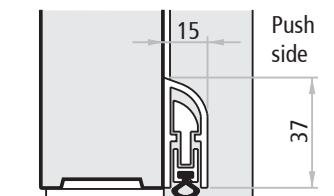
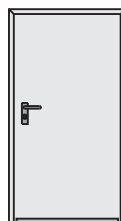

Lengths avail.	FM L active leaf	FM L secondary leaf
430 mm	from 500 to 520	from 407 to 506
530 mm	from 521 to 620	from 507 to 606
630 mm	from 621 to 720	from 607 to 706
730 mm	from 721 to 820	from 707 to 806
830 mm	from 821 to 920	from 807 to 906
930 mm	from 921 to 1020	from 907 to 1006
1030 mm	from 1021 to 1120	from 1007 to 1106
1130 mm	from 1121 to 1220	from 1107 to 1206
1230 mm	from 1221 to 1320	from 1207 to 1306
1330 mm	from 1321 to 1340	from 1307 to 1330

## PROTECTIVE PLATES AND KICKPLATES

On request for 1 and 2 leaf Univer and Proget doors, specifying the side of application (pull or push).

Their main function is to protect the parts of the door that are vulnerable to being scraped by carts, hospital beds, etc. They are made of AISI 304 satinized stainless steel sheet metal with a standard height of 230 mm.

For on-site attachment with two-sided adhesive factory applied on the back, at the bottom of the door (kick plate) or at handle height (protective plate).



Holes are factory prepared for the passage of the handle panel and cylinder.

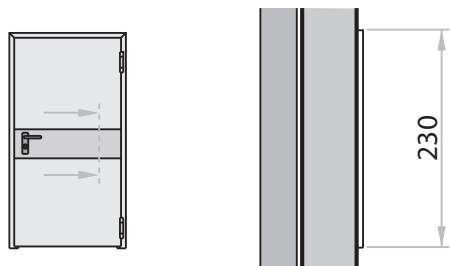

Protection plates



Holes are factory prepared for the passage of the handle panel and cylinder.

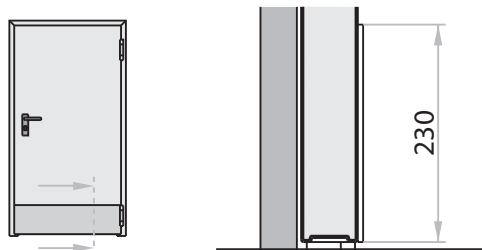

Kick plates



# Drip-steel profile - Wall screws - Subframe

For NINZ doors



## DRIP-STEEL PROFILE

On request for Univer and Proget doors. Normally used to prevent condensation from dripping down the door leaf and puddling beneath the door. The profile is made of "Sendzimir" processed galvanized sheet metal painted the color of the door leaf. It is applied to the exterior side of the door on site after being cut to measure, to be attached with the screws provided.

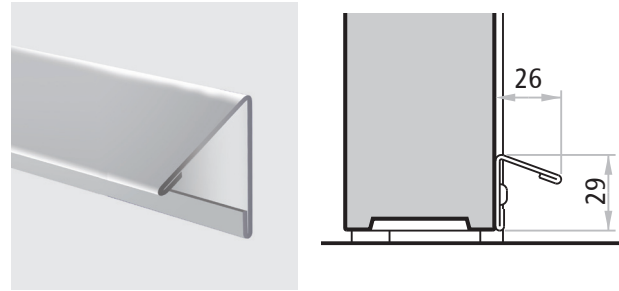

Lengths avail.	FM L door leaf
710 mm	to 800
810 mm	to 900
910 mm	to 1000
1260 mm	to 1350

## WALL SCREWS FOR FASTENING WITHOUT PLUGS

Field of use: installation of Proget REI 60/120 and multipurpose doorframes to the wall or subframe using screws but no plugs. Designed for installation into concrete, full bricks, half-full bricks, lightened cement and other materials. **Advantages:** saves time and money thanks to direct attachment of the frame to the wall, with no need to enlarge the holes for plugs. Thanks to the black galvanization, the screws blend in smoothly with the FC sealing.

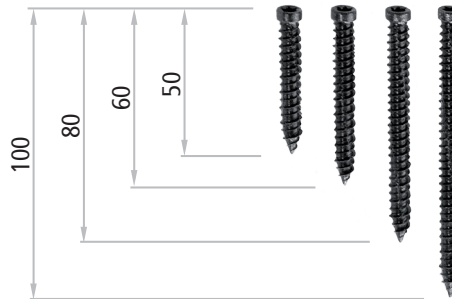

Dimensions	description
Ø 7.5 x 50 mm	for attachment to metal subframes
Ø 7.5 x 60 mm	for attachment to concrete and especially thick walls
Ø 7.5 x 80 mm	for attachment to walls of average thickness
Ø 7.5 x 100 mm	for attachment to walls of lower thickness

## NOTE

Holes should be drilled using a Ø 6 mm stone drill bit.

## SUBFRAME

Subframe (to be ordered) in hollow 30 x 15 x 2mm steel profiles (recommended for REI 60 and REI 120 Proget doors) equipped with anchors for mortar fixing and spacers that are to be removed during final installation.

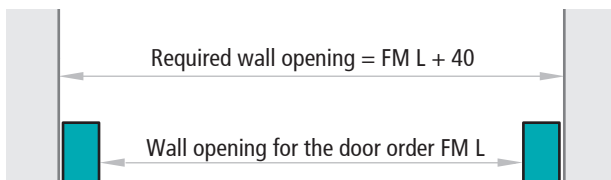

Horizontal cross section

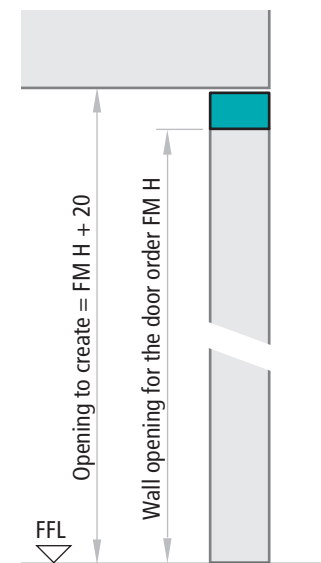

Vertical cross section

# MAC® Multifunctional Access Control

## Controlled opening system

The MAC system makes it possible to activate the handle to open the door using the same mechanical components as for normal functioning.

The particularity of the MAC system is that it concentrates all of the command and control functions in the lock, which simplifies the electrical work required on site.

### The MAC system offers multiple advantages, such as:

- possibility of 12 V AC/DC or 24 V AC/DC power supplies, which avoids problems due to inadequate voltage
- *low current absorption:*
  - at 12 V the startup current is 500 mA for the first 5-6 sec., before changing to a 250 mA maintenance current
  - at 24 V the startup current is 1 A for 300 millisecond., before settling to 500 mA for 4-5 sec. and finally changing to a 250 mA maintenance current for the remaining 25 sec.
- timer incorporated, time set at 30 sec. with automatic reset (zeroing of the timer) every time the door is opened, eliminating the need for external timers
- red/green LED on the backplate to prevent useless forcing of the handle by signaling whether the opening system is active or not
- continuous handle activation (always open when desired)
- remote LED for remote signaling of lock activation/deactivation

The MAC system comes pre-assembled with the door, including the wiring inside the door leaf and the electrical contacts between the leaf and the frame.

*Included pre-assembled on the door: anti-panic lock with solenoid and electronic chip with timer incorporated (1), double electrical contacts between leaf and frame (2), internal wiring inside the leaf (3)*

*Included in the package: handle and backplate with red/green LED and connectors (4)*

*Not included: power supply for doorframe contacts (5), opening button and command accessories (6)*

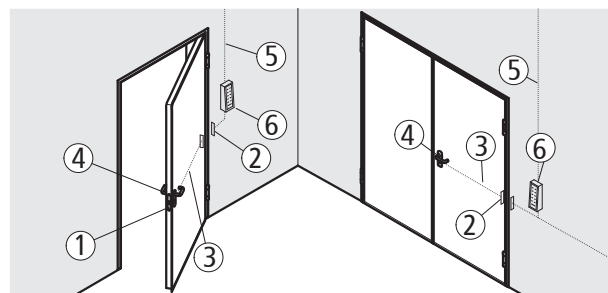
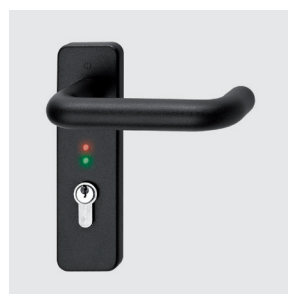
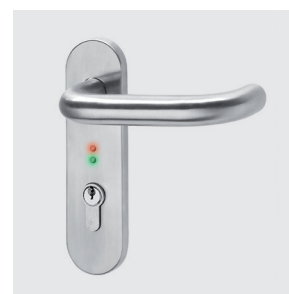

Diagram of components



Nylon handle with red/green LED



Stainless steel handle with red/green LED

## MAC 1 SYSTEM

### Operation mode

The MAC 1 system controls access from the pull side of the door. With the lock locked by key, opening is only possible with electrical consent (button, switch, badge reader, etc.) which activates the handle, while opening is always possible from the push side by means of the panic bar or emergency handle. Activation of the handle is signaled by illumination of the "green LED," while the "red LED" indicates when the handle is idle. Both LEDs are off when no power is being supplied.

### Time mode

In this mode, the activation time lasts 30 seconds before the handle is returned to idle. If the door is opened within the 30 seconds, the timer is automatically reset to zero.

### Continuous mode

"open setting": in this mode, handle activation is controlled by an electrical switch (not included) that provides continuous power to the MAC 1 lock. The green LED remains lighted, being turned off only from the time the door is opened until it is fully closed once again.

**MAC 1 can be combined with any BM type panic bar and M3 emergency handles.**

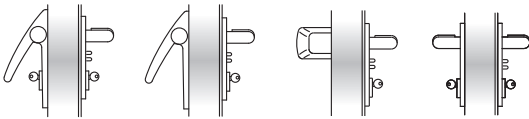

EX DC BM    EX/TW BM    SL BM    M3

## MAC 2 SYSTEM

### Operation mode

The MAC 2 system controls access from both sides of the door. With the lock locked by key, opening is only possible with electrical consent (button, switch, badge reader, etc.) which activates both handles. Activation of both handles is signaled by illumination of the "green LED," with the "red LED" signaling when the handles are idle. Both LEDs are off when no power is being supplied.

### Time mode

In this mode, the activation time lasts 30 seconds before both handles are returned to idle. If the door is opened within the 30 seconds, the timer is automatically reset to zero.

### Continuous mode

"open setting": in this mode, the activation of both handles is controlled by an electrical switch (not included) that provides continuous power to the MAC 2 lock. The green LED remains lighted for both handles, being turned off only from the time the door is opened until it is fully closed once again.

**MAC 2 can be combined with M1 (black nylon) and M1X (stainless steel) handles.**

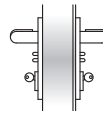

### NOTE

Both systems have been REI 120 fire-tested to ensure compliance of the certified product

# Electric handle

## Controlled opening system

### ELM/MT MULTI-VOLTAGE ELECTRIC HANDLE

Controlled door opening system that employs an electronic device to activate the handle. The latter is equipped with an internal timer with a 30 seconds time allowance for opening the door, after which the electric handle is deactivated. The handle can be activated for longer time periods by means of the electrical switch. The illumination of a green LED and sounding of an acoustic signal (buzzer) indicate handle activation, while a red LED indicates deactivation.

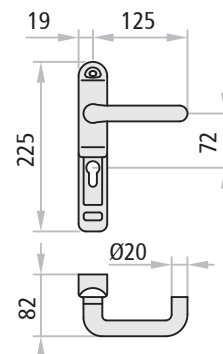
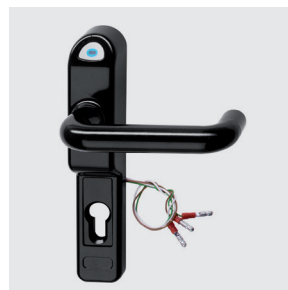

#### When ordered together with the door, the ELM/mt system includes:

electric handle, electrical contacts between the leaf and the frame, power cable inside the door connected to electrical contacts, command panel, lock and fixing screws.

#### If ordered separately from the door, the system includes:

electric handle, command panel and fixing screws.

#### Technical data

power supply	12 Vcc/Vca - 24 Vcc/Vca
current absorbed at 12 V	500 mA
current absorbed at 24 V	200 mA
startup current at 12 V	700 mA
startup current at 24 V	300 mA

### ELM/CISA MULTI-VOLTAGE CISA ELECTRIC HANDLE

Controlled door opening system that employs an electronic device to activate the handle. Equipped with a separate timer (for insertion into the switch box) which can be set for different opening times: from a minimum of 0,1 second to a maximum of 10 days. Equipped with green LED that signal activation of the handle.

The ELM/cisa system includes: electric handles, 2 meters of power cable, cable sleeve for the connection between the leaf and the frame, 8/9 square spindle, fixing screws, adjustable timer packaged separately.

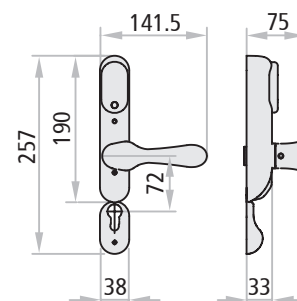
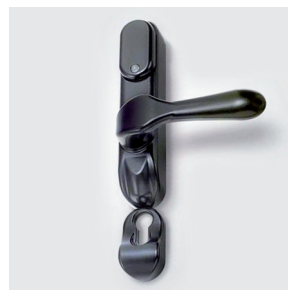

#### Technical data

power supply	12 Vcc/Vca - 24 Vcc/Vca
current absorbed	330 mA
startup current	800 mA
operational temperature	-20°C ÷ +80°C
max. relative ambient humidity	95%

#### NOTE

The electric handle requires assembly.

# Electric handle

## Controlled opening system

### OPENING SYSTEM FOR COMBINATION WITH ELM/MT OR ELM/CISA ELECTRIC HANDLE

#### Panic bars

The controlled opening direction is from the pull side of the door (electric handle side). Locking the lock by key blocks the electric handle functioning, while opening is still possible via the panic bar on the push side.  
Use: one- or two-leaved doors for anti-panic exits when access control is desired on the pull side.

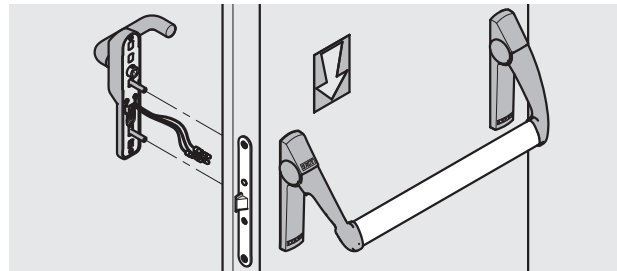

Exus

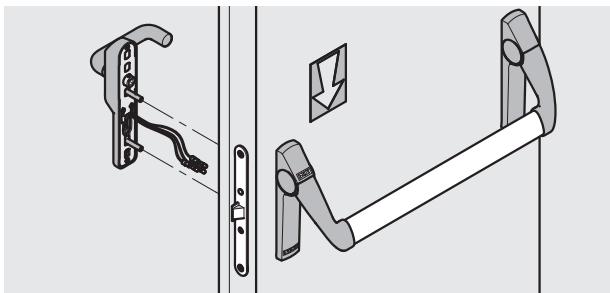

Twist

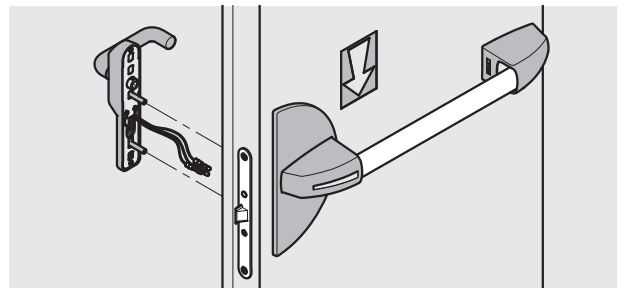

Slash

#### MSC Handles

Use: one- or two-leaved doors when control is desired for one of the two opening directions. Locking with the key blocks opening in both directions.  
Controlled opening may be for either the push or pull direction, depending on where the electric handle is applied.

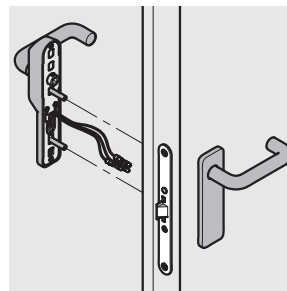

MSC

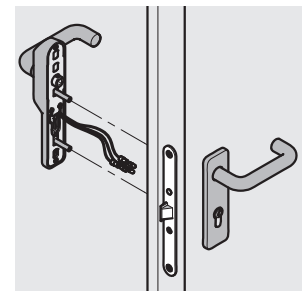

MCC/S

#### MCC/S Handles

Use: for one- or two-leaved doors where access is to be controlled from the pull side only (electric handle side). Locking with the key blocks opening from the push side, but not from the side where the electric handle is applied.

### OPENING SYSTEM FOR COMBINATION WITH ELM/MT ELECTRIC HANDLE

#### Emergency handles M3

Use: one- or two-leaved doors for emergency exits when access control is desired on the pull side.  
The controlled opening direction is from the pull side of the door (electric handle side). Locking the lock by key blocks the operation of the electric handle, while opening remains possible via the M3 emergency handle.

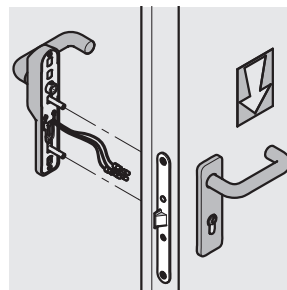

M3

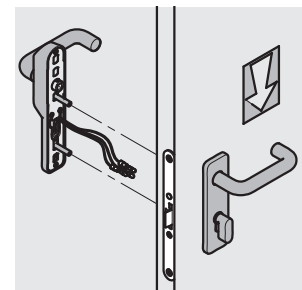

HOT-CIL

#### Emergency handles HOT/CIL

Use: for the doors of hotel rooms  
The controlled opening direction is from the push side of the door (electric handle side). Closing with the thumb-turn latch from inside the room, the opening by electric handle is possible only with an electric consent. Opening is always possible from the room side of the door.

### ELECTROMAGNETS 13700 TD

This system is for use in special situations when the doors remain closed and should only be opened with electrical consent. The electrically powered electromagnet holds the door closed with a holding force of approximately 300 kg, rendering the action of the handle ineffective. Only electrical commands (badge reader, key button, etc.) or electrical consent from the fire detector system can deactivate the electromagnet making a door opening possible.

#### Operation mode

The door is held closed by the electromagnet (01) and the bolt of the lock. Opening from the outside can happen via magnetic card (04) using the Badge reader (02) of the card control system or any other system of choice and by retracting the bolt using the handle or key.

From the inside, the deactivation of the electromagnet is caused by the unlock button (03) (also remotely) or with the same system used for the pull side, while the locking bolt must still be retracted using the handle or key. The activated electromagnet signals its state with a red LED, whereas the green LED signals the temporary deactivation. Further a relay AC/DC signaling the electromagnetic state is supplied.

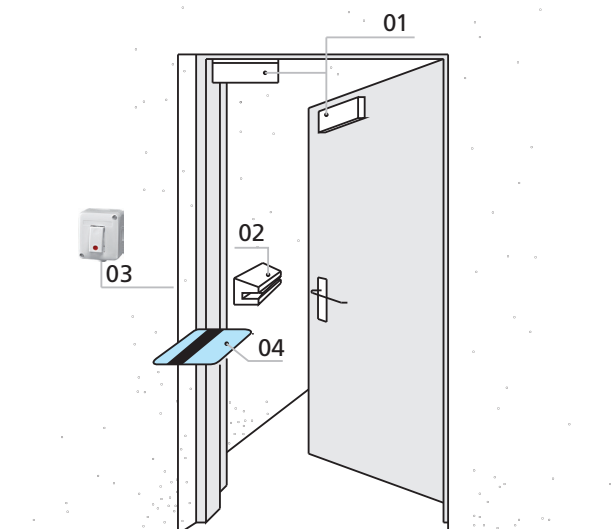

#### NOTE

Unlocking of the door is only possible if the door is not locked by key.

#### Technical data

model	13700 TD	withstand force	fino a 300 Kg.
power supply	12/24 Vcc	time delay	0 ÷ 90 sec.
current absorbed at 12 V	500 mA	electrom. compatib standard	EMC - UNI CEI 70011
current absorbed at 24 V	250 mA	certificate Nr.	0123/02

### COMPONENTS INCLUDED WITH THE ELECTROMAGNET CONTROLLED OPENING SYSTEM

#### For Proget doors

Electromagnet 13700 TD holding force 300 kg, 12/24 V DC, fastener plate, anchor with stainless steel fastener backplate.

#### For Rever/Univer doors

Electromagnet 13700 TD withstanding force 300 kg, 12/24 V DC, fastener plate and angle bar, anchor with stainless steel fastener backplate.

#### Control system:

- "Access" code keypad
- Card-based control system
- Biometric "TOCA access" reader
- Unlock button

#### NOTE

Detailed specifications for the Control system are found on the "Command accessories" page.



PROGET Electromagnet



REVER/ UNIVER Electromagnet

# Power supply/command accessories

For MAC® - ELM/mt - ELM/cisa Electromagnet 13700 TD controlled opening systems

**NINZ**<sup>®</sup>  
FIREDOORS

## CONTROL SYSTEMS AND RELATED ACCESSORIES

### „Access“ code keypad

Power supply 12-18 V ACV DC with 10 numeric buttons plus an Enter key, including control unit for 1 door and timer incorporated (0,5÷25 sec.). Up to 500 recordable different codes, composed from 1 to 6 digits.



„Access“ code keypad

### Card-based control system

Card control system with timer incorporated (art. 55611 + 55613 + 55615), including Badge reader, control unit, flat cable, external 230 V DC/15 V DC transformer, three blank badges and a coded badge.



Card-based control system

### „TOCA access“ biometric reader

„TOCA access“ biometric reader for reading fingerprints and transforming them into key codes. Includes an internal unit for registering, memorizing and cancelling users and external unit for fingerprints. Autonomous low voltage 9 V AC power supply.



Biometric reader

### Unlock button

Unlock button (art. GW 20 523), with white casing and control light.



Unlock button

### Power Supply Switching 12 V DC/3 A

With different management options:

- max. Nr. 10 MAC® Multifunction Access Control \*
- or max. Nr. 5 13700 TD Electromagnets
- or max. Nr. 5 ELM/mt Electric handles \*
- or max. Nr. 8 ELM/cisa Electric handles \*



Power Supply Switching 12 V DC/3 A

\* provided that they are not commanded simultaneously

# Door-holding systems

For fire doors and gates



## C2 MONO-ZONE MICROPROCESSOR

Certified in accordance with EN 1154-2 and EN 1154-4 standards.

The processor was designed and built in conformity with UNI EN 1154 standards, which regulate processors for fire alarms and related accessories which each must conform with EN1154 standards.

### Technical data

model	52002
primary power supply	230 V AC, 100 mA, 50-60Hz
auxiliary power supply	2 batteries, 12 V DC/1,1 ÷ 1,3 Ah
minimum output current	264 mA
maximum output current	424 mA
buffer battery charger output	24 V DC (27.6 V DC)
protection rating	IP30
operational temperature	-5°C ÷ +40°C
operational zones	single zone (mono-zone)
acoustic alarm	internal buzzer
"low battery" signal	intermittent internal buzzer
EC certification	0051-CPD-0264
conformity with standards	EN 1154-2 +A1:2006 EN 1154-4:1997 + A1:2002 + A1:2006

### ATTENTION

According to standard EN 1154-4, it is obligatory for the mono-zone processor to be equipped with:

- Nr. 1 heat/smoke detector RFC cert. EN 1154-7
- Nr. 1 pair of buffer batteries
- Nr. 1 external electronic siren cert. EN 1154-3
- Nr. 1 alarm activation button cert. EN 1154/11

## RFC HEAT AND SMOKE DETECTOR

Certified in accordance with UNI EN 1154-5 and EN 1154-7 standards.

RFC heat and smoke detector characterized by white ABS casing. Optical/thermic operation with intervention temperature to be set between 54 and 65°C. To ensure proper functioning, the detectors must be subjected to regular 6-month maintenance checks. Please note that it is inadvisable to position the sensor where strong air currents are present.

### Technical data

operational voltage	10 ÷ 30 V DC, typically 24 V DC
consumption at rest, at 24 V DC	70 µA
absorption of alarm at 24 V DC	50 mA

## BUFFER BATTERIES

Pair of rechargeable buffer batteries, 12 V DC/1.2 Ah

### NOTE

All DOOR-HOLDING SYSTEMS are supplied in separate packaging and require on-site assembly.

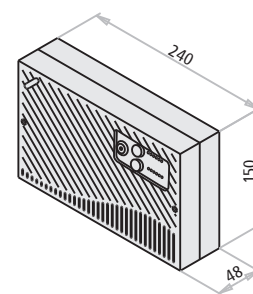

This is a control unit which administers the door-holding electromagnets for fire doors, where standards require consideration of every possible and imperponderable event that could happen during normal functioning. The following, therefore, are subject to constant monitoring: all exits towards the smoke and heat detectors, the alarm and reset buttons, the external siren and the charge of the two batteries. The microprocessor itself, which functions as the brain of the system, is constantly monitored at regular intervals by a specific system routine that checks for proper functioning of the operational software. Any hitches, breakdowns or malfunctions are signaled by one of the ten LED diodes on the front panel, and the internal buzzer provides an additional acoustic signal for specific cases. Alarm or breakdown situations can then be reset at three different levels depending on the seriousness of the event: by a button located near the microprocessor, by a first button on the front of the microprocessor unit and by a second button on the same panel that requires key selector activation (key in possession of the safety manager). A fourth reset level is then supplied for the circuit only (operation executable by authorized technical personnel only).

### MANAGES

- max. Nr. 5 RFC heat/smoke detectors
- max. Nr. 5 alarm activation buttons
- max. Nr. 2 electronic sirens
- Nr. 4 EM or EMP electromagnets
- Nr. 2 buffer batteries

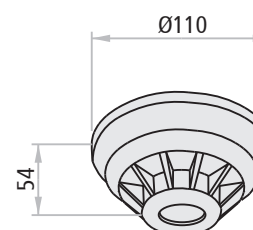

### Technical data

operational temperature	-40°C ÷ +60°C
conformity with	EN 1154-5, EN 1154-7 standards





# Door-holding systems

For fire doors and gates

## ELECTRONIC SIREN

Includes a volume control function for installation in internal and external environments. The connection is made using double clamps (6) for branching.

### Technical data

power supply	9 ÷ 28 V DC
absorption by alarm at 12 V DC	8 mA
absorption by alarm at 24 V DC	16 mA
protection rating	IP65
operational temperature	-25°C ÷ +70°C
conformity with standard	EN 1154-3



With 28 or 32 selectable tones and a second tone for two-phase alarms.

Dimensions:  
Ø 91 x 91mm.

## ALARM ACTIVATION BUTTON

Pressure on the plastic front plate activates the electrical contact. Re-arming of the contact is executed manually using a key (provided).

### Technical data

power supply	max. 30 V DC
protection rating	IP41
operational temperature	max. +65°C
internal exchange contact	n.o./n.c.
conformity with standard	EN 1154-11



In red color ABS with a weight of 110 gr.

Dimensions:  
99 x 95 x 43mm.

## EM ELECTROMAGNET



EM wall electromagnet with white plastic casing, complete with unlock button. Anchor consisting of a nickel-plated plate and a jointed baseboard.

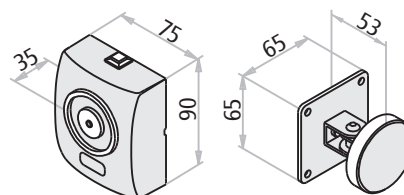

### Technical data

power supply	24 V DC
absorption	60 mA
minimum withstand force	55 Kg.
EC certification	0407-CPD-011 (IG-098-2004) /02
conformity with standard	EN 1155

## EMP ELECTROMAGNET



EMP floor electromagnets, consisting of a galvanized metal core with an unlock button and a fastener plate. Anchor consisting of a nickel-plated plate and jointed baseboard.

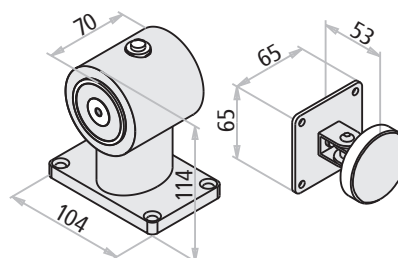

### Technical data

power supply	24 V DC
absorption	60 mA
minimum withstand force	55 Kg.
EC certification	0407-CPD-011 (IG-098-2004)
conformity with standard	EN 1155

## NOTE

All DOOR-HOLDING SYSTEMS are supplied in separate packaging and require on-site assembly.

# Provisions/Standards

For emergency exit devices / Anti-panic devices for safety exits



## EN 1125:2008 AND EN 179:2008 STANDARDS

New European standards for CE marked safety exit and emergency exit devices entered into effect on 01 January 2010, replacing the previous EN 1125: 1997 + A1:2001 and EN 179:1997 standards.

Standard EN 1125: 2008 specifies the requirements for manufacturing, performance levels and testing of anti-panic exit devices activated mechanically by a horizontal bar and designed for specific use in panic situations along escape routes.

Standard EN 179: 2008 specifies the requirements for the manufacturing, performance levels and testing of emergency exit devices activated mechanically by a lever handle or push panel.

CE conformity of the anti-panic and emergency exit devices with the standard requirements must be demonstrated by initial type testing and production controls carried out by the manufacturer under the continuous observation of the certifying body.

### Performance and safety requirements

- Device selection depends on the risk analysis of its use when installed along escape routes or emergency exits.
- Anti-panic devices are only required to conform with standard EN 1125, permitting exit at any time by a single operation on the horizontal bar that requires no prior knowledge of how the device functions and that permits opening even when the door is subjected to a load. These requirements simulate the forces that could be applied by people who are in a state of panic.
- Standard EN 179 concerns emergency devices designated for use in emergency situations involving people who are accustomed to using safety exits and their devices, and who are therefore unlikely to be taken by panic.
- Devices for anti-panic or emergencies must be designed so that the door can be opened from the inside at any time in less than 1 second.
- Materials used for anti-panic exit devices must remain operational at temperatures between -10° and + 60°.
- **Verification is required for suitability of use with fire/smoke resistant doors, and this verification may only be received by passing a fire resistance test on both sides of the door in conformity with EN 1634-1.**
- **It is extremely important that anti-panic and emergency devices not be used on fire doors that have a higher fire resistance time than the level for which the device itself has been approved.**
- To reduce the risk of entrapping fingers and/or blocking the device, checks based on visual inspection and measurement with appropriate calipers is prescribed.
- Protrusions and corners that could cause harm to persons must be smoothed down.
- Anti-panic or emergency exit devices that activate upper and lower vertical rods (on the passive leaf, for instance) must ensure that manipulation of the lower rod does not activate the upper rod.
- The strike box mounted on the floor must not rise higher than 15 mm and must be tapered in the direction of the escape route.
- Periodic lubrication must be possible without requiring disassembly of the device.
- For door masses greater than 200 kg and leaf dimensions greater than 1320 x 2520 mm, additional testing under harsher conditions are required.
- The durability of the device may be classified as grade 6 (100,000 cycles) or grade 7 (200,000 cycles). For secondary leaves, grade 6 corresponds to 10,000 cycles, and for grade 7 - 20,000 cycles.
- The presence of an external door furniture (key, cylinder, lever handle, doorknob, etc.) must not in any way interfere with the activation of the internal anti-panic or emergency device.

# Provisions/Standards

For emergency exit devices / Anti-panic devices for safety exits



- **External door furnitures other than those provided by the anti-panic device manufacturer is not considered to conform with standards.**
- External door furnitures provided by the manufacturer may have either manual or electrical operation (e.g., electric handle or lock activated electrically by the handle).
- The material used to make the device must not contain or release dangerous substances in greater amounts than prescribed by European standards or national regulations.
- Anti-panic and emergency exit devices must be accompanied by clear, detailed instructions for installation and maintenance, including a list of all of the elements that have been tested and approved for use of the device and that could be provided separately.
- **It is essential for anti-panic and emergency exit devices to be installed according to the manufacturer's instructions using duly compatible components only.**
- Horizontal bars and levers must normally be installed at a height range of 900 to 1100 mm above the finished floor level, as measured in the closed position. If it is known that children represent the majority of the rooms' occupants, a reduction in bar height should be considered.
- Once the device has been installed, the instructions should be handed over to the user, who must preserve them for use during maintenance operations.
- **To ensure that performance conforms with certifications, regular maintenance checks need to be carried out at intervals of one month or less, with periodic checks that all of the system's components still correspond to the component list provided at the outset.**

## OFFICIAL GAZETTE OF THE EUROPEAN UNION 04 JULY 2009

### Information from member states:

**Commission communication in the context of the application of Directive 89/106/CEE of the Council in relation to the approach of regulatory and administrative legislative provisions of Member States in regards to construction products.**

OEN (1)	Reference and title of the standard	Reference of the substitute standard
CEN	EN 1125:2008 Lock accessories Anti-panic devices for safety exits activated by horizontal bar - Test methods and requirements	EN 1125/1997
CEN	EN 179:2008 Lock accessories Emergency exit devices activated by lever handles or push plates	EN 179/1997

Date of the standard's entry into effect as a harmonized European standard	Date of expiration of the co-existence period
1.1.2009	1.1.2010

### EC MARKING ACCORDING TO EN 179:2008

How to read the **CE** marking:

	EC conformity marking consisting of the "CE" symbol indicated in Directive 93/68/CE																				
<b>M3 device for emergency exits</b>	Product description																				
<b>Ninz S.p.A. Corso Trento, 2/A I-38061 ALA (TN)/ITALY</b>	Name or identifying mark and registered address of the manufacturer																				
<b>10</b>	Last two digits of the year when the marking was applied																				
<b>EN 179:2008</b>	Standard number																				
<b>0425</b>	Identification number for the certifying body																				
<b>2147-CPD-2010</b>	EC certification number																				
<table border="1"> <tr> <td><b>3</b></td><td><b>7</b></td><td><b>7</b></td><td><b>B</b></td><td><b>1</b></td><td><b>4</b></td><td><b>4</b></td><td><b>2</b></td><td><b>A</b></td><td><b>A</b></td> </tr> <tr> <td>1st</td><td>2nd</td><td>3rd</td><td>4th</td><td>5th</td><td>6th</td><td>7th</td><td>8th</td><td>9th</td><td>10th</td> </tr> </table>	<b>3</b>	<b>7</b>	<b>7</b>	<b>B</b>	<b>1</b>	<b>4</b>	<b>4</b>	<b>2</b>	<b>A</b>	<b>A</b>	1st	2nd	3rd	4th	5th	6th	7th	8th	9th	10th	Product classification
<b>3</b>	<b>7</b>	<b>7</b>	<b>B</b>	<b>1</b>	<b>4</b>	<b>4</b>	<b>2</b>	<b>A</b>	<b>A</b>												
1st	2nd	3rd	4th	5th	6th	7th	8th	9th	10th												

### CLASSIFICATION ACCORDING TO EN 179:2008

How to read the classification:

#### Category of use (1st character)

Only one category of use is applicable:  
 - grade 3: very frequent use with little need to pay attention, in the sense of the possibility of accidents or improper use.

#### Durability (2nd character)

Two different durability ratings are applicable:  
 - grade 6: 100,000 test cycles;  
 - grade 7: 200,000 test cycles.

#### Mass of the door (3rd character)

Three different grades of door mass are applicable:  
 - grade 5: up to 100 kg;  
 - grade 6: up to 200 kg;  
 - grade 7: over 200 kg.

#### Suitability for use with fire/smoke rated doors (4th character)

Three different grades are applicable:  
 - grade 0: non approved for use on fire/smoke rated doors;  
 - grade A: suitable for use on smoke rated doors;  
 - grade B: suitable for use on fire/smoke rated doors; on the basis of testing in conformity with EN 1634-1.

#### Human safety (5th character)

Only a single human safety rating is applicable:  
 - grade 1: all devices for panic exits must ensure human safety, so for purposes of the present standard only the maximum rating is allowed.

#### Corrosion resistance (6th character)

The two different corrosion resistance ratings indicated in EN 1670:2007 are applicable:  
 - grade 3: 96 h (high resistance);  
 - grade 4: 240 h (extra-high resistance).

#### Material safety (7th character)

Five different material safety grades are applicable:  
 - grade 2: 1000N  
 - grade 3: 2000N  
 - grade 4: 3000N  
 - grade 5: 5000N

#### Protrusion of horizontal bar (8th character)

Two different grades of device protrusion are applicable:  
 - grade 1: protrusion up to 150 mm (extra protrusion);  
 - grade 2: protrusion up to 100 mm (standard protrusion).

#### Activation type (9th character)

Two activation types are applicable:  
 - type A: emergency exit device with lever handle activation  
 - type B: emergency exit device with push panel activation (SLASH, for example).

#### Field of door application (10th character)

Four different categories of field of door application are applicable, depending on the final use of the emergency exit device:  
 - category A: one-leaved door, two-leaved door: active or passive leaf, push opening;  
 - category B: only one-leaved doors, push opening;  
 - category C: two-leaved doors, passive leaf only, push opening;  
 - category D: one-leaved doors only, pull opening.

### EC MARKING ACCORDING TO EN 1125:2008

How to read the **CE** marking:

	EC conformity marking consisting of the "CE" symbol indicated in Directive 93/68/CE																				
<b>EXUS Panic exit device</b>	Product description																				
<b>Ninz S.p.A. Corso Trento, 2/A I-38061 ALA (TN)/ITALY</b>	Name or identifying mark and registered address of the manufacturer																				
<b>08</b>	Last two digits of the year when the marking was applied																				
<b>EN 1125:2008</b>	Standard number																				
<b>0425</b>	Identification number for the certifying body																				
<b>1228-CPD-2007</b>	EC certification number																				
<table border="1"> <tr> <td><b>3</b></td> <td><b>7</b></td> <td><b>7</b></td> <td><b>B</b></td> <td><b>1</b></td> <td><b>3</b></td> <td><b>2</b></td> <td><b>1</b></td> <td><b>A</b></td> <td><b>A</b></td> </tr> <tr> <td>1st</td> <td>2nd</td> <td>3rd</td> <td>4th</td> <td>5th</td> <td>6th</td> <td>7th</td> <td>8th</td> <td>9th</td> <td>10th</td> </tr> </table>	<b>3</b>	<b>7</b>	<b>7</b>	<b>B</b>	<b>1</b>	<b>3</b>	<b>2</b>	<b>1</b>	<b>A</b>	<b>A</b>	1st	2nd	3rd	4th	5th	6th	7th	8th	9th	10th	Product classification
<b>3</b>	<b>7</b>	<b>7</b>	<b>B</b>	<b>1</b>	<b>3</b>	<b>2</b>	<b>1</b>	<b>A</b>	<b>A</b>												
1st	2nd	3rd	4th	5th	6th	7th	8th	9th	10th												

### CLASSIFICATION ACCORDING TO EN 1125:2008

How to read the classification:

#### Category of use (1st character)

There is only one category of use that may be utilized:  
 - grade 3: very frequent use with little need to pay attention, in the sense of the possibility of accidents or improper use.

#### Durability (2nd character)

Two different durability ratings are applicable:  
 - grade 6: 100,000 test cycles;  
 - grade 7: 200,000 test cycles.

#### Mass of the door (3rd character)

Three different grades of door mass are applicable:  
 - grade 5: up to 100 kg;  
 - grade 6: up to 200 kg;  
 - grade 7: over 200 kg.

#### Suitability for use with fire/smoke resistant doors (4th character)

Three different grades are applicable:  
 - grade 0: non approved for use on fire/smoke resistant doors;  
 - grade A: suitable for use on smoke resistant doors;  
 - grade B: suitable for use on fire/smoke resistant doors; on the basis of testing in conformity with EN 1634-1.

#### Human safety (5th character)

Only a single human safety rating are applicable:  
 - grade 1: all devices for panic exits must ensure human safety, so that for purposes of the present standard only the maximum rating is allowed.

#### Corrosion resistance (6th character)

The two different corrosion resistance ratings indicated in EN 1670:2007 are applicable:  
 - grade 3: 96 h (high resistance);  
 - grade 4: 240 h (extra-high resistance).

#### Material safety (7th character)

Only a single material safety rating are applicable:  
 - grade 2: there is only one category that represents the minimum obtainable rating due to the fact that material safety must be viewed as secondary relative to human safety.

#### Protrusion of horizontal bar (8° character)

Two different grades of horizontal bar protrusion are applicable:  
 - grade 1: protrusion up to 150 mm (extra protrusion);  
 - grade 2: protrusion up to 100 mm (standard protrusion).

#### Horizontal bar activation type (9th character)

Two activation types are applicable:  
 - type A: panic bars with push-bar activation (EXUS and TWIST, for example);  
 - type B: panic bars with touch-bar activation (SLASH, for example).

#### Field of door application (10th character)

Three different categories of field of door application are applicable, depending on the final use of the safety exit device:  
 - category A: one-leaved door, two-leaved door: active or secondary leaf, push opening;  
 - category B: only one-leaved doors, push opening;  
 - category C: two-leaved doors, secondary leaf only, push opening.

## TESTING EQUIPMENT

Our company maintains its own testing and experimentation equipment in order to ensure maximum quality, reliability and innovative service to our customers.



## PRESENTATION

### Emergency exit devices (emergency handles)

Ninz S.p.A. is a leader in fire doors, and has once again re-asserted itself as a visionary company with a strong identity created by its continuous research into the design and technology of its own products, such as the new line of emergency exit handles.

The handles are **CE** marked and pre-certified according to European standard EN 179:2008, which entered in effect January 01, 2010, and which prescribes a several substantial changes that further extend the requirements for maximum safety and ease of opening.

### The Kit designed for your needs

When ordered separately from the door, the M3, M3X, M14, M14X, Hot CIL and HOT CIL-X handles are packaged in functional KITS for display and presentation in the most appropriate distribution context.

Packaging in KITS ensures customers, installers and therefore the final users that they are receiving a complete anti-panic system with fully corresponding and **CE** certified parts.

### Certifications and replacements

Given the importance of maintaining the entire system's **CE** conformity, special attention has been paid to replacement parts, which have been subjected to testing in accordance with the EN 179:2008 standard due to their pivotal role in maintaining **CE** certification.

The only way to ensure that the products maintain their original characteristics over time is by using original NINZ replacement parts.

For this reason, the instructions for emergency handles include additional indications regarding proper installation and maintenance plus a exploded assembly drawing that specifies every smallest detail of the certified system with all of the references required for ordering replacement parts.

### NOTE

Handles are considered to be accessories and assembly is required.



# M3 emergency handle

Emergency handle for internal locks - EN 179:2008

## M3 IN BLACK NYLON

### Description

Lever handle for emergency exit:

- Reversible for right or left opening
- Applicable to single leaf doors or the active leaf (main leaf) of two-leaved doors located at emergency exits
- Suitable for Rever/Univer/Proget doors and other types of emergency exit doors
- Both the levers and the backplates are made of black nylon, and the core of the lever and the internal installation plate are made of galvanized steel
- The lock is anti-panic/fire rated for European profile cylinders
- Cylinder to pass in nickel-plated brass with 3 keys
- Suitable for doors with dimensions up to 1350 x 2880 mm/leaf, mass up to 300 kg/leaf, with ratings up to EI<sub>120</sub> - REI120 and smoke resistance, handle protrusion of 65 mm

### Applications

The M3 lever handle for emergency exits is for use on doors designated for emergency situations involving people who are accustomed to using safety exits and their hardware, and who are therefore unlikely to be in a state of panic.

### Operation mode

With the lock locked by key, the door can no longer be opened from the pull side, while the door can still be opened using the lever on the push side.

## VERSIONS AVAILABLE

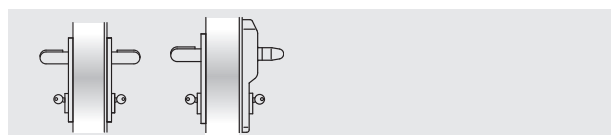

M3

M3 ELM/mt

## VARIATIONS ON REQUEST

- MAC1 type panic lock, including access control mode
- Panic lock with 3 closing points (for multipurpose PROGET doors only)
- Mastered or coded cylinders

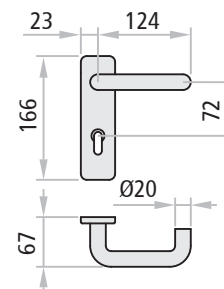
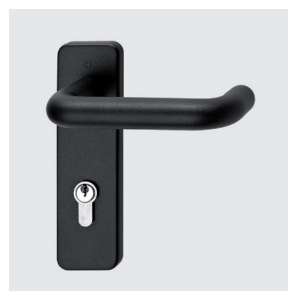

## SUPPLIED TOGETHER WITH THE DOOR

### For single leaves or the active leaf (main leaf) of two-leaved doors:

*Included (mounted on the door):* anti-panic lock with 65 mm entrance and the strike box insert.

*Included (in the package):* Nr. 2 black nylon lever handles, Nr. 2 galvanized steel internal installation plates, Nr. 2 black nylon backplates, Nr. 1 split square spindle, Nr. 1 standard nickel-plated double cylinder with 3 keys, Nr. 1 adhesive pictogram (green arrow), Nr. 1 instruction/maintenance manual.

*Versions available:* M3, M3 ELM/mt.

*ELM electric handle:* see the dedicated pages

## M3 KIT VERSION

### (SUPPLIED SEPARATELY FROM THE DOOR)

### KIT for single leaf or the active leaf of two-leaved doors:

Specify the leaf thickness in the order.

*KIT contents:* Nr. 1 anti-panic lock with 65 mm entrance, Nr. 1 strike box insert, Nr. 2 black nylon lever handles, Nr. 2 galvanized steel internal installation plates, Nr. 2 black nylon backplates, Nr. 1 split square spindle, Nr. 1 standard nickel-plated double cylinder with 3 keys, Nr. 1 adhesive pictogram (green arrow), Nr. 1 instruction/maintenance manual.

*Versions available:* M3



# M3X emergency handle

Emergency handle for internal locks - EN 179:2008

## M3X IN STAINLESS STEEL

### Description

Lever handle for emergency exit:

- Reversible for right or left opening
- Applicable to single leaf doors or the active leaf (main leaf) of two-leaved doors located at emergency exits
- Suitable for Rever/Univer/Proget doors and other types of emergency exit doors
- The levers as well as the internal installation plates are made of AISI 304 satinized stainless steel, and the backplates are made of galvanized steel
- The lock is anti-panic/fire rated for Euro profile cylinders
- Cylinder to pass in nickel-plated brass with 3 keys
- Suitable for doors with dimensions up to 1350 x 2880 mm/leaf, mass up to 300 kg/leaf, with fire resistance up to EI<sub>120</sub> - REI120 and smoke resistance, handle protrusion of 75 mm

### Use

The M3X emergency exit handle are to be applied on doors designated for emergency situations in which the people involved are accustomed to using safety exits and their opening devices, and therefore who are very unlikely to be in a state of panic.

### Operation mode

With the lock locked by key, the door can no longer be opened from the pull side, but the door can still be opened from the push side using the handle.

## VERSIONS AVAILABLE

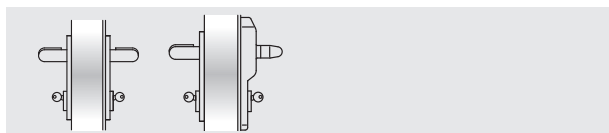

M3X

M3X ELM/mt

## VARIATIONS ON REQUEST

- MAC1 panic lock, including access control system
- Panic lock with 3 closing points (for multipurpose PROGET doors only)
- Mastered or coded cylinders

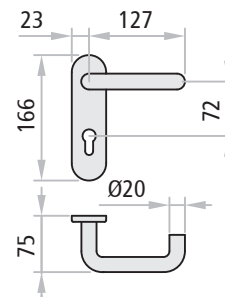

## SUPPLIED TOGETHER WITH THE DOOR

### For single leaves or the active leaf (main leaf) of two-leaved doors:

*Included (mounted on the door):* anti-panic lock with 65 mm entrance and the strike box insert.

*Included (in the package):* Nr. 2 stainless steel lever handles, Nr. 2 galvanized steel internal installation plates, Nr. 2 stainless backplates, Nr. 1 split square spindle, Nr. 1 standard nickel-plated double cylinder with 3 keys, fastener screws, Nr. 1 adhesive pictogram (green arrow), Nr. 1 instruction/maintenance manual.

*Versions available:* M3X, M3X ELM/mt.

*ELM electric handle:* see the dedicated pages

## M3X KIT VERSION

### (SUPPLIED SEPARATELY FROM THE DOOR)

### KIT for single leaf or the active leaf of two-leaved doors:

Specify the leaf thickness in the order.

*KIT contents:* Nr. 1 anti-panic lock with 65 mm entrance, Nr. 1 strike box insert, Nr. 2 black nylon lever handles, Nr. 2 galvanized steel internal installation plates, Nr. 2 black nylon backplates, Nr. 1 split square spindle, Nr. 1 standard nickel-plated double cylinder with 3 keys, fastener screws, Nr. 1 adhesive pictogram (green arrow), Nr. 1 instruction/maintenance manual.

*Versions available:* M3X

# Certifications

## Emergency handle for internal locks - EN 179:2008



### M3, M3X CERTIFICATIONS

Suitable for one-leaved doors or the active leaf of two-leaved doors with dimensions up to 1350 x 2880 mm/leaf and a mass of 300 kg/leaf

<b>Denomination</b>	M3, M3X DEVICE FOR EMERGENCY EXITS
<b>Manufacturer</b>	Ninz S.p.A. Corso Trento, 2/A I-38061 ALA (TN)/ITALY
<b>Year application trademark</b>	10
<b>Nr. and year of the standard</b>	EN 179:2008
<b>Certifying body</b>	0425
<b>CE certificate Nr.</b>	2147-CPD-2010
<b>Classification</b>	<b>3 7 7 B 1 4 4 2 A A</b>

- 1st Category of use very frequent
- 2nd Durability 200.000 cycles
- 3rd Door mass over 200 kg
- 4th Suitable for fire/smoke rated doors
- 5th Safety, suitable for evacuation routes
- 6th High corrosion resistance 240 h
- 7th Material safety 1000 N
- 8th Handle protrusion up to 100 mm
- 9th Activation type with lever handle
- 10th Suitable for one- or two-leaved doors

**ATTESTATO DI CONFORMITÀ**  
DIRETTIVA 89/106/CEE

**CERTIFICATE OF CONFORMITY**  
DIRECTIVE 89/106/CEE

Questo certificato è rilasciato in conformità a quanto prescritto dall'Art.6 par.2 lettera b) del DPR 21 aprile 1993, n°246 (Direttiva 89/106/CEE) ed attesta la conformità del prodotto di seguito identificato agli Art.1, Art.2 ed allegato A del DPR 21 aprile 1993, n°246 (Direttiva 89/106/CEE)

This certificate is issued in accordance with the requirements defined in Article 6 par.2 lett. B) of DPR 21st April 1993, n°246 (89/106/CE Directive) and certifies the compliance of the product to art. 1, art. 2 and annex A of DPR 21st April 1993, n°246 (89/106/CE Directive)

<b>ATTESTATO N°</b>	<b>2147 - CPD - 2010</b>	<b>CERTIFICATE N°</b>
<b>Organismo notificato</b>	<b>Notified Body</b>	
ICIM S.p.A. - Piazza Don Mapelli, 75 - 20099 SESTO SAN GIOVANNI	Identification number: 0425	
<b>Dati Fabbricante</b>	<b>Manufacturer details</b>	
Sede legale	NINZ S.p.A. Corso Trento, 2/A 38061 ALA (TN) ITALY	Head office
Unità operativa		Production unit
<b>Dati prodotto</b>	<b>Product details</b>	
Tipologia	Type	
	DISPOSITIVI PER USCITE DI EMERGENZA AZIONATI MEDIANTE MANIGLIA A LEVA O PIASTRA A SPINTA	
	<b>EMERGENCY EXIT DEVICES OPERATED BY A LEVER HANDLE OR PUSH PAD</b>	
Denominazione	Dispositivo di emergenza serie "M3" "M3X"	Denomination
Serrature antipanico	art. AP16/18, 3201001.018, SCA 1 3201001.019/020, MAC 1 3201001.041/042	
Coppia di deviatori	art. 4201010	
Riscontro serratura	art. 2401006, 2401005, 2401015, 2401014, 2401035, 3412001	
Aste verticali	art. 3305013	
Comandi	art. 3101001.009 (M3), 3101017.003 (M3X)	
Sistema di attestazione della conformità	1	System of attestation of conformity
Norma di riferimento	EN 179:2008	
Standard reference		
Classificazione	3   7   7   B   1   4   4   2   A   A	Classification
<b>Eventuali estensioni</b>	Nessuna / None	
<b>Extensions</b>		
<b>Eventuali condizioni di subordinazione della Certificazione CE</b>	Nessuna / None	
<b>Condition of subordination of CE certification</b>		

Il presente attestato è valido esclusivamente per il prodotto indicato. Eventuali varianti da apportare devono essere approvate da ICIM SpA  
The present certificate is valid only for the product described above. Every change has to be approved by ICIM S.p.A.

<b>Data di emissione</b> Issue date	<b>Emissione corrente</b> Current issue	<b>Data di scadenza</b> Expiring date	<b>ICIM S.p.A.</b> Il Presidente Ing. Tullio Badino
12/03/2010	12/03/2010	11/03/2020	

# HOT-CIL Emergency handle

Emergency handle for internal locks - EN 179:2008

## HOT-CIL IN BLACK NYLON

### Description

Lever handle and fixed doorknob for emergency exits, especially for hotel rooms:

- Reversible for right or left opening
- Normally applied on single leaf doors or the active leaf of two-leaved doors if the secondary leaf normally remains closed and can only be opened manually with the latch bolt (019)
- Suitable for Rever/Univer/Proget doors and other types of emergency exit pull doors
- The lever, doorknob and even the backplates are made of black nylon, while the core of the lever and the internal installation plates are made of galvanized steel
- The lock is anti-panic/fire rated pull type for Euro profile cylinders
- Mastered cylinder to pass with thumbturn latch on the pull side made of nickel-plated brass with 3 keys
- Suitable for doors with dimensions up to 1350 x 2880 mm/leaf, mass up to 300 kg/leaf, with fire rating EI<sub>2</sub>120 - REI120 and smoke resistance, handle protrusion of 65 mm

### Use

The HOT-CIL emergency exit handle is to be applied on doors designated for emergency situations in which the people involved are accustomed to using safety exits and their opening devices, and who are therefore very unlikely to be in a state of panic.

### Operation mode

The door can be opened from the push side by key only, while it can be opened at any time from the pull side by pressing the handle, even when the lock is locked using the key. The lock has two bolts that protrude when the key or the thumbturn latch is turned.

## VERSIONS AVAILABLE

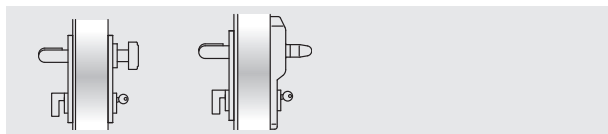

HOT-CIL

HOT-CIL ELM/mt

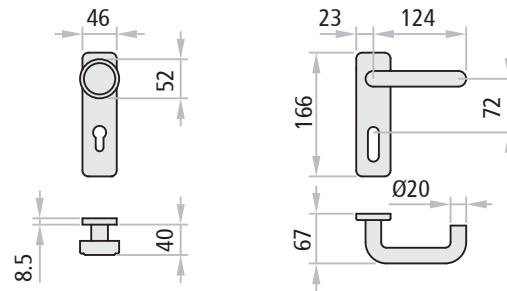

## SUPPLIED TOGETHER WITH THE DOOR

**For the single leaf or active leaf (main leaf) of two-leaved doors (the secondary leaf normally remains closed and can only be opened manually using the bolt lock (019)):**

*Included (mounted on the door):* the anti-panic lock with 65 mm entrance and the strike box insert.

*Included (in the package):* Nr. 1 lever handle and Nr. 1 fixed doorknob in black nylon, Nr. 2 galvanized steel internal installation plates, Nr. 2 black nylon backplates, Nr. 1 square spindle, Nr. 1 mastered cylinder to pass with thumbturn latch on the pull side made of nickel-plated brass with 3 keys, fastener screws, Nr. 1 adhesive pictogram (green arrow), Nr. 1 set of instructions for installation/maintenance.

*Versions available:* HOT-CIL, HOT-CIL ELM/mt.

*ELM electric handle:* see the dedicated pages.

## HOT-CIL KIT VERSION

### (SUPPLIED SEPARATELY FROM THE DOOR)

**KIT for single leaf door or the active leaf (main leaf) of two-leaved doors (the secondary leaf normally remains closed and can only be opened manually using the bolt lock (019)):**

Specify the leaf thickness in the order.

*KIT contents:* Nr. 1 anti-panic lock with 65 mm entrance, Nr. 1 strike box insert, Nr. 1 lever handle and Nr. 1 fixed doorknob in black nylon, Nr. 2 galvanized steel internal installation plates, Nr. 2 black nylon backplates, Nr. 1 square spindle, Nr. 1 mastered cylinder to pass with thumbturn latch on the pull side made of nickel-plated brass with 3 keys, fastener screws, Nr. 1 adhesive pictogram (green arrow), Nr. 1 set of instructions for installation/maintenance.

*Versions available:* HOT-CIL

# HOT-CIL-X Emergency handle

Emergency handle for internal locks - EN 179:2008

**NINZ**<sup>®</sup>  
FIREDOORS

## HOT-CIL-X IN STAINLESS STEEL

### Description

Lever handle and fixed doorknob for emergency exits, especially for hotel rooms:

- Lever handle and fixed doorknob for emergency exits, especially for hotel rooms:
- Reversible for right or left opening
- Normally applied on single leaf doors or the active leaf of two-leaved doors if the secondary leaf normally remains closed and can only be opened manually with the latch bolt (019)
- Suitable for Rever/Univer/Proget doors and other types of emergency exit pull doors
- The lever, doorknob and plates are made of AISI 304 satinized stainless steel, while the backplates are made of galvanized steel
- The lock is anti-panic/fire rated for Euro profile cylinders
- Mastered cylinder to pass with thumbturn latch on the pull side made of nickel-plated brass with 3 keys
- Suitable for doors with dimensions up to 1350 x 2880 mm/leaf, masses up to 300 kg/leaf, fire rated to EI<sup>2</sup>120 - REI120 and smoke resistance, handle protrusion of 75 mm

### Application

The HOT-CIL-X emergency exit handle is for use on doors designated for emergency situations in which the people involved are accustomed to using safety exits and their opening devices, and who are therefore very unlikely to be in a state of panic.

### Operation mode

The door can be opened from the push side by key only, while it can be opened at any time from the pull side by pressing the handle, even when the lock is locked using the key. The lock has two bolts that protrude when the key or the thumbturn latch is turned.

## VERSIONS AVAILABLE

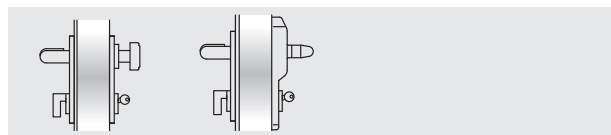

HOT-CIL-X

HOT-CIL-X ELM/mt

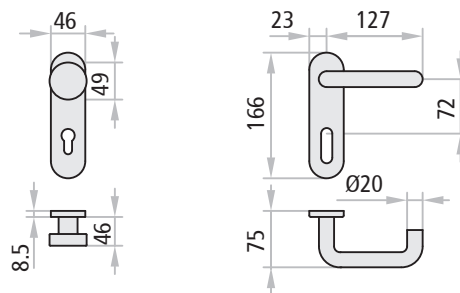

## SUPPLIED TOGETHER WITH THE DOOR

**For the single leaf or active leaf (main leaf) of two-leaved doors (the passive leaf (secondary) normally remains closed and can only be opened manually using the bolt lock (019)):**

*Included (mounted on the door):* the anti-panic lock with 65 mm entrance and the strike plate insert.

*Included (in the package):* Nr. 1 lever handle and Nr. 1 fixed doorknob in satinized stainless steel, Nr. 2 galvanized steel internal installation plates, Nr. 2 backplates in satinized stainless steel, Nr. 1 square spindle, Nr. 1 mastered cylinder to pass with thumbturn latch on the pull side made of nickel-plated brass with 3 keys, fastener screws, Nr. 1 adhesive pictogram (green arrow), Nr. 1 set of instructions for installation/maintenance.

*Versions available:* HOT-CIL-X, HOT-CIL-X ELM/mt.

*ELM electric handle:* see the dedicated pages.

## HOT-CIL-X KIT VERSION

**(SUPPLIED SEPARATELY FROM THE DOOR)**

**KIT for single leaf door or the active leaf (main leaf) of two-leaved doors (the passive leaf (secondary) normally remains closed and can only be opened manually using the bolt lock (019)):**

Specify the leaf thickness in the order.

*KIT contents:* Nr. 1 anti-panic lock with 65 mm entrance, Nr. 1 strike plate insert, Nr. 1 lever handle and Nr. 1 fixed doorknob in satinized stainless steel, Nr. 2 galvanized steel internal installation plates, Nr. 2 backplates in satinized stainless steel, Nr. 1 square spindle, Nr. 1 mastered cylinder to pass with thumbturn latch on the pull side made of nickel-plated brass with 3 keys, fastener screws, Nr. 1 adhesive pictogram (green arrow), Nr. 1 set of instructions for installation/maintenance.

*Versions available:* HOT-CIL-X

# Certifications

Emergency handle for internal locks - EN 179:2008



## HOT-CIL, HOT-CIL-X CERTIFICATION

Suitable for one-leaved doors or two-leaved doors with the second leaf semi-fixed and not equipped with emergency or anti-panic devices, with dimensions up to 1350 x 2880 mm/leaf, masses of 300 kg/leaf.

<b>Denomination</b>	HOT-CIL, HOT-CIL-X EMERGENCY EXIT DEVICE
<b>Manufacturer</b>	Ninz S.p.A. Corso Trento, 2/A I-38061 ALA (TN)/ITALY
<b>Year application trademark</b>	10
<b>Nr. and year of the standard</b>	EN 179:2008
<b>Certifying body</b>	0425
<b>CE certificate Nr.</b>	2149-CPD-2010
<b>Classification</b>	<b>3 7 7 B 1 4 4 2 A D</b>

1st	Category of use very frequent
2nd	Durability 200.000 cycles
3rd	Door mass over 200 kg
4th	Suitable for fire/smoke rated doors
5th	Safety, suitable for evacuation routes
6th	High corrosion resistance 240 h
7th	Material safety 1000 N
8th	Handle protrusion up to 100 mm
9th	Activation type with lever handle
10th	Suited for one-leaved doors

		<b>ATTESTATO DI CONFORMITÀ</b> DIRETTIVA 89/106/CEE <b>CERTIFICATE OF CONFORMITY</b> DIRETTIVA 89/106/CEE		
<small>Questo certificato è rilasciato in conformità a quanto prescritto dall'Art.5 par.2 lettera b) del DPR 21 aprile 1993, n°246 (Direttiva 89/106/CEE) ed attesta la conformità del prodotto di seguito identificato agli Art.1, Art.2 ed allegato A del DPR 21 aprile 1993, n°246 (Direttiva 89/106/CEE) This certificate is issued in accordance with the requirements defined in Article 6 par.2 lett. B) of DPR 21th April 1993, n° 246 (89/106/CE Directive) and certifies the compliance of the product to art. 1, art. 2 and annex A of DPR 21th April 1993, n° 246 (89/106/CE Directive)</small>				
<b>ATTESTATO N°</b>	<b>2149 - CPD - 2010</b>		<b>CERTIFICATE N°</b>	
<b>Organismo notificato</b>	ICIM S.p.A. - Piazza Don Mapelli, 75 - 20099 SESTO SAN GIOVANNI		<b>Notified Body</b> Identification number: 0425	
<b>Dati Fabbricante</b>	Sede legale: NINZ S.p.A. Corso Trento, 2/A 38061 ALA (TN) ITALY Unità operativa:		<b>Manufacturer details</b> Head office: Production unit:	
<b>Dati prodotto</b>	<b>DISPOSITIVI PER USCITE DI EMERGENZA AZIONATI MEDIANTE MANIGLIA A LEVA O PIASTRA A SPINTA</b> <b>EMERGENCY EXIT DEVICES OPERATED BY A LEVER HANDLE OR PUSH PAD</b>		<b>Product details</b> Type	
Tipologia	DISPOSITIVI PER USCITE DI EMERGENZA AZIONATI MEDIANTE MANIGLIA A LEVA O PIASTRA A SPINTA		Type	
Denominazione	Dispositivo di emergenza	serie "HOT-CIL" "HOT-CIL-X"	Denomination	
Serrature antipánico	art. 3201001.011			
Coppia di deviatori	art. 4201010			
Riscontro serratura	art. 2401006, 2401005, 2401015, 2401014			
Comandi	art. 3101001.012 (M2), 3101017.002 (M2X)			
Sistema di attestazione della conformità	1		System of attestation of conformity	
Norma di riferimento	EN 179:2008		Standard reference	
Classificazione	3   7   7   B   1   4   4   2   A   D		Classification	
<b>Eventuali estensioni</b>	Nessuna / None		<b>Extensions</b>	
<b>Eventuali condizioni di subordinazione della Certificazione CE</b>	Nessuna / None		<b>Condition of subordination of CE certification</b>	

Il presente attestato è valido esclusivamente per il prodotto indicato. Eventuali varianti da apportare devono essere approvate da ICIM SpA  
The present certificate is valid only for the product described above. Every change has to be approved by ICIM S.p.A.

<b>Data di emissione</b> Issue date	<b>Emissione corrente</b> Current issue	<b>Data di scadenza</b> Expiring date	<b>ICIM S.p.A.</b> Il Presidente Ing. Tullio Badino
12/03/2010	12/03/2010!	11/03/2020	

# M14 emergency handle

Emergency handle for insertion in lock - EN 179:2008

## M14 IN BLACK NYLON

### Description

Lever handle for emergency exit:

- Reversible for right or left opening
- For application to the secondary leaf of two-leaved doors located at emergency exits
- Suitable for Rever/Univer/Proget doors and other types of emergency exit doors
- The lever and plate are both made of black nylon, while the core of the lever and the internal installation plate are made of galvanized steel
- The safety lock is anti-panic fire rated, activates the vertical rods and ensures automatic closure
- Suitable for doors with dimensions up to 1350 x 2880 mm/leaf, masses up to 300 kg/leaf, with fire rating EI<sub>120</sub>
- REI120 and smoke resistance, handle protrusion of 65 mm

### Use

The M14 emergency exit handle is to be applied to doors designated for emergency situations in which the people involved are accustomed to using safety exits and their opening devices, and who are therefore highly unlikely to be in a state of panic.

The active (main) leaf must also be equipped with an anti-panic or emergency device.

### Operation mode

The M14 emergency device is always used in combination with a second device for safety or emergency exits that is applied to the active (main) leaf, and for this reason does not include external opening door furnitures.

From the push side, opening is possible at any time by pushing on the handle, which causes the vertical rods to retract and at the same time pulls back the bolt of the active leaf's lock, unlatching both doors.

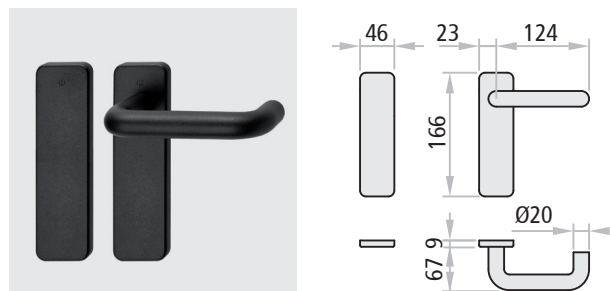

### SUPPLIED TOGETHER WITH THE DOOR

#### For the secondary leaf of two-leaved doors:

*Included (mounted on the door):* anti-panic safety lock with 80 mm entrance, vertical rods, upper locking device, upper strike plate.

*Included (in the package):* Nr. 1 lever handle (black nylon), Nr. 2 galvanized steel internal installation plates, Nr. 2 blank black nylon backplates, Nr. 1 square spindle, Nr. 1 floor-mounted floor catch, Nr. 1 companion arm (for fire doors only), fastener screws, Nr. 1 adhesive pictogram (green arrow), Nr. 1 set of instructions for installation/maintenance.

### M14 KIT VERSION

#### (SUPPLIED SEPARATELY FROM THE DOOR)

#### KIT for single leaf or the active leaf of two-leaved doors:

Please specify the door type - REVER, UNIVER or PROGET - in the order.  
*KIT contents:* Nr. 1 anti-panic safety lock with 80 mm entrance, Nr. 1 lever handle (black nylon), Nr. 2 galvanized steel installation plates, Nr. 2 blank black nylon backplates, Nr. 1 square spindle, Nr. 1 upper locking device (for Rever and Univer multipurpose only), Nr. 1 companion arm (excluding Rever and Univer multipurpose doors), fastener screws, Nr. 1 adhesive pictogram (green arrow), Nr. 1 set of instructions for installation/maintenance.

# M14X emergency handle

## Emergency handle for internal locks - EN 179:2008



### M14X IN STAINLESS STEEL

#### Description

Lever handle for emergency exit:

- Reversible for right or left opening
- For application to the secondary leaf of two-leaved doors located at emergency exits
- Suitable for Rever/Univer/Proget doors and other types of emergency exit doors
- The lever and backplates are both made of AISI 304 satinized stainless steel, while the internal installation plates are made of galvanized steel
- The safety lock is anti-panic/fire rated, activates the vertical rods and ensures automatic closure
- Suitable for doors with dimensions up to 1350 x 2880 mm/leaf, mass up to 300 kg/leaf, with fire rating EI<sub>2</sub>120 REI120 and smoke resistance, handle protrusion of 65 mm

#### Use

The M14X emergency exit handle is to be applied on doors designated for emergency situations in which the people involved are accustomed to using safety exits and their opening devices, and who are therefore highly unlikely to be in a state of panic.

The active (main) leaf must also be equipped with an anti-panic or emergency device.

#### Operation mode

The M14X emergency device is always used in combination with a second device for safety or emergency exits that is applied to the active leaf, and for this reason does not include external opening door furnitures.

From the push side, opening is possible at any time by pushing on the handle, which causes the vertical rods to retract and at the same time pulls back the bolt of the active leaf's lock, unlatching both doors.

### M14, M14X CERTIFICATION

Suited for the secondary leaf of two-leaved doors with dimensions up to 1350 x 2880 mm/leaf, masses of 300 kg/leaf.

Denomination	M14 EMERGENCY EXIT DEVICE
Manufacturer	Ninz S.p.A. Corso Trento, 2/A I-38061 ALA (TN)/ITALY
Year application trademark	10
Nr. and year of the standard	EN 179:2008
Certifying body	0425
CE certificate Nr.	2148-CPD-2010
Classification	<b>3 7 7 B 1 4 4 2 A C</b>

- 1st Category of use very frequent
- 2nd Durability 200.000 cycles
- 3rd Door mass over 200 kg
- 4th Suitable for fire/smoke rated doors
- 5th Safety, suitable for evacuation routes
- 6th High corrosion resistance 240 h
- 7th Material safety 1000 N
- 8th Handle protrusion up to 100 mm
- 9th Activation type with lever handle
- 10th Suited for door: two-leaved, on the secondary leaf only

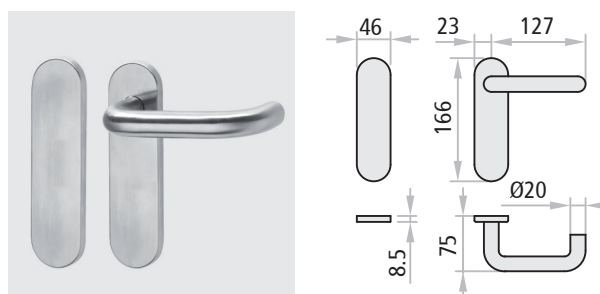

### SUPPLIED TOGETHER WITH THE DOOR

#### For the secondary leaf of two-leaved doors:

*Included (mounted on the door):* anti-panic safety lock with 80 mm entrance, vertical rods, upper locking device, upper strike plate.

*Included (in the package):* Nr. 1 lever handle in satinized stainless steel, Nr. 2 galvanized steel internal installation plates, Nr. 2 blank backplates in satinized stainless steel, Nr. 1 square spindle, Nr. 1 floor-mounted door catch, Nr. 1 companion arm (for fire doors only), fastener screws, Nr. 1 adhesive pictogram (green arrow), Nr. 1 set of instructions for installation/maintenance.

### KIT M14X VERSION

#### (SUPPLIED SEPARATELY FROM THE DOOR)

#### KIT for single leaf or the active leaf of two-leaved doors:

Please specify the door type - REVER, UNIVER or PROGET - in the order.

*KIT contents:* Nr. 1 anti-panic safety lock with 80 mm entrance, Nr. 1 lever handle in satinized stainless steel, Nr. 2 galvanized steel internal installation plates, Nr. 2 backplates in satinized stainless steel, Nr. 1 square spindle, Nr. 1 upper locking device (for Rever and Univer multi-purpose only), Nr. 1 companion arm (excluding Rever and Univer multi-purpose doors), fastener screws, Nr. 1 adhesive pictogram (green arrow), Nr. 1 set of instructions for installation/maintenance.

ATTESTATO DI CONFORMITÀ DIRETTIVA 89/106/CEE CERTIFICATE OF CONFORMITY DIRETTIVE 89/106/CEE		CE 0425
Questo certificato è rilasciato in conformità a quanto prescritto dall'Art.6 par.2 lettera b) del DPR 21 aprile 1993, n°246 (Direttiva 89/106/CEE) ed attesta la conformità del prodotto di seguito identificato agli Art.1, Art.2 ed allegato A del DPR 21 aprile 1993, n°246 (Direttiva 89/106/CEE)		
This certificate is issued in accordance with the requirements defined in Article 6 par.2 lett. B) of DPR 21th April 1993, n°246 (89/106/CEE Directive) and certifies the compliance of the product to art. 1, art. 2 and annex A of DPR 21th April 1993, n°246 (89/106/CEE Directive)		
ATTESTATO N°	2148 - CPD - 2010	CERTIFICATE N°
Organismo notificato	ICIM S.p.A. - Piazza Don Mapelli, 75 - 20099 SESTO SAN GIOVANNI	Notified Body Identification number: 0425
Dati Fabbricante	NINZ S.p.A. Corso Trento, 2/A 38061 ALA (TN) ITALY	
Sede legale		Head office
Unità operativa		Production unit
Dati prodotto	Product details	
Tipologia	DISPOSITIVI PER USCITE DI EMERGENZA AZIONATI MEDIANTE MANIGLIA A LEVA O PIASTRA A SPINTA EMERGENCY EXIT DEVICES OPERATED BY A LEVER HANDLE OR PUSH PAD	
Denominazione	Dispositivo di emergenza serie "M14" "M14X"	Denomination
	Controserrature antipánico art. AP020P, AP020U, 3201001.006	
	Dispositivo superiore art. 3105080, 3105024, 3305003	
	Riscontro asta art. 2401046, 2401044, 2401002	
	Boccola pavimento art. 2401001, 2401007, 3105091, 2401020	
	Aste verticali art. 3305015, 3305016, 3305002, 3305006	
	Comandi art. 3101001.008 (M14), 3101017.004 (M14X)	
Sistema di attestazione della conformità		System of attestation of conformity
Norma di riferimento		Standard reference
EN 179:2008		
Classificazione		Classification
3   7   7   B   1   4   4   2   A   C		
Eventuali estensioni	Nessuna / None	
Eventuali condizioni di subordinazione della Certificazione CE	Nessuna / None	
Il presente attestato è valido esclusivamente per il prodotto indicato. Eventuali varianti da apportare devono essere approvate da ICIM SpA The present certificate is valid only for the product described above. Every change has to be approved by ICIM S.p.A.		
Data di emissione Issue date	Emissione corrente Current issue	Data di scadenza Expiring date
12/03/2010	12/03/2010!	11/03/2020
		ICIM S.p.A. Il Presidente Ing. Tullio Badino





## PRESENTATION

### EXUS® panic bars

Ninz S.p.A. is a leader in fire doors, and has once again reasserted itself as a visionary company with a strong identity created by its continuous research into the design and technology of its own products, such as the new line of EXUS® panic bars.

The EXUS® panic bars are CE marked and according to European standard EN 1125:2008, which entered in effect January 01, 2010, and which prescribes a series of substantial changes that further extend the requirements for maximum safety and ease of opening.

### The KIT designed for your needs

When ordered separately from the door, the EXUS® series of panic bars is provided in elegant and functional KITS packaged for presentation in the most appropriate format for distribution.

Packaging in KITS ensures customers, installers and therefore the final users that they are receiving a complete anti-panic system with fully corresponding parts which are all CE certified.

### Finishing

Attention to detail and proportions are highlighted by select materials and finishing.

In addition to the **black NYLON** version combined with **anodized ALUMINUM** bars, new combinations include the all **satined STAINLESS STEEL** version and the **polished chromed ALUMINUM** version combined with the **anodized ALUMINUM** bar. Many other color and surface combinations are possible for equally aesthetic solutions. The particular aesthetics of soft forms is one of the exclusive advantages of **EXUS® panic bars**, representing the fruit of designs generated in collaboration with Studio MM Design, which has been working with the company for many years.

### Certifications and replacements

Given the importance of maintaining the entire system's CE conformity, special attention has been paid to replacement parts, which have been subjected to testing in accordance with the EN 1125:2008 standard due to their pivotal role in maintaining CE certification.

The only way to ensure that the products maintain their original characteristics over time is by using **original NINZ replacement parts**.

For this reason, the instructions for **EXUS® panic bars** include additional indications regarding proper installation and maintenance plus a exploded assembly drawing that specifies every smallest detail of the certified system with all of the references required for ordering replacement parts.

With the new EXUS® panic bar, NINZ S.p.A. demonstrates its willingness to believe in market development by investing in designs and company image in order to endow its own products with added value while maintaining highly competitive quality-price ratios.



Black NYLON handle

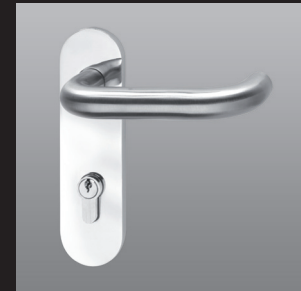

ALUMINUM handle with STAINLESS STEEL lever handle and chromed ALUMINUM backplate



Satined STAINLESS STEEL handle

### NOTE

By default external door furniture is provided with the same finishing as the panic bar.

# EXUS® - Features, certifications

Panic bar



## FEATURES

- Newly designed product with state of the art technological concept
- Available several in color and surface combinations: satinized stainless steel for the lever arms and the bar, or aluminum with polished chrome lever arms and anodized aluminum bar, and finally the classic evergreen combination - black nylon lever arms with anodized aluminum bar
- Certified for internal lock with 40 or 65 mm entrances for single leaves or active leaves, with 30 or 80 mm entrance for secondary leaves and with square spindle rotation of up to 45°
- Possibility of locking by key on the bar side as well
- Reversible for Right or Left mounting
- Protrusion 125 mm
- Proposed together with the door or separately in a complete KIT packaged in a black/yellow box
- Label applied to the packaging to identify the product's characteristics
- Wide range of customizations: colored bar, colored or stainless steel handles, lock with access control mechanisms, special coded or mastered cylinders

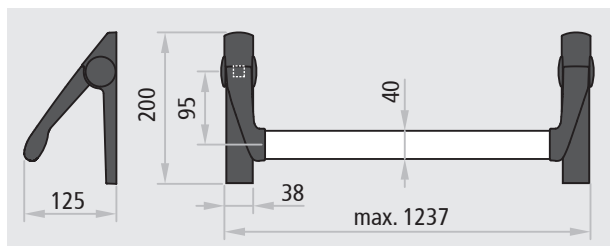

## CERTIFICATION

Suited for one-leaved doors or the active and secondary leaves of two-leaved doors with dimensions up to 1350 x 2880 mm/leaf, masses of 300 kg/leaf

<b>CE</b>	
Denomination	EXUS PANIC BAR
Manufacturer	Ninz S.p.A. Corso Trento, 2/A I-38061 ALA (TN)/ITALY
Year application trademark	08
Nr. and year of the standard	EN 1125:2008
Certifying body	0425
CE certificate Nr.	1228-CPD-2007
Classification	<b>3 7 7 B 1 3 2 1 A A</b>

- 1st Category of use very frequent
- 2nd Durability 200.000 cycles
- 3rd Door mass over 200 kg
- 4th Suitable for fire/smoke rated doors
- 5th Safety, suitable for evacuation routes
- 6th High corrosion resistance 96 h
- 7th Material safety 1000 N
- 8th Bar protrusion up to 150 mm
- 9th Activation type with push bar
- 10th Suited for one- or two-leaved doors



EXUS® is a registered trademark owned by Ninz S.p.A.

Also suited for doors with fire ratings:



<b>ATTESTATO DI CONFORMITÀ</b> DIRETTIVA 89/106/CEE		<b>CE</b> 0425
<b>CERTIFICATE OF CONFORMITY</b> DIRECTIVE 89/106/CEE		
<small>Questo certificato è rilasciato in conformità a quanto prescritto dall'Art.6 par.2 lettera b) del DPR 21 aprile 1993, n°246 (Direttiva 89/106/CEE) ed attesta la conformità del prodotto di seguito identificato agli Art.1, Art.2 ed allegato A del DPR 21 aprile 1993, n°246 (Direttiva 89/106/CEE)</small>		
<small>This certificate has been issued in conformity to what prescribed by the Art.6 par.2 letter b) of the DPR 21/04/1993, n°246 (Directive 89/106/CEE) and certifies the conformity of the product described below to the Art.1, Art.2 and attachment A of DPR 21/04/1993, n°246 (Directive 89/106/CEE)</small>		
<b>ATTESTATO N°</b>	<b>1228 - CPD - 2007</b>	<b>CERTIFICATE N°</b>
<b>Organismo notificato</b>	<b>ICIM S.p.A. - Piazza Don Mapelli, 75 - 20099 Sesto San Giovanni (MI) ITALY</b>	<b>Notified Body</b>
<b>Dati Fabbricante</b>	<b>Sede legale: NINZ S.p.A. Corso Trento, 2/A - 38061 ALA (TN) ITALY</b> Unità operativa	<b>Manufacturer</b> Head office Operative unit
<b>Dati prodotto</b>	<b>DISPOSITIVI ANTIPANICO PER USCITE DI SICUREZZA AZIONATI MEDIANTE UNA BARRA ORIZZONTALE</b> <b>PANIC EXIT DEVICES</b>	<b>Product</b> Type
Tipologia	serie "TWIST" "EXUS LP" "EXUS LA" "EXUS LX"	Denominazione
Serrature antipanico	art. AP10/16, SCA 1 3201001 019020, MAC 1 3201001 0411042, 4506002 17 (V), 3201001 018 465-65-0	
Controserrature antipanico	art. APQ20P, AR300L, 4509002 18 (V), 3201001 6, 43193 95.	
Dispositivo superiore	art. 3105000, 3105024, 4509003 (V), 3305003.	
Riscontro asta	art. 2401005, 2401046, 2401044, 4506005 (V), 2401002.	
Boccola pavimento	art. 2401001, 2401007, 3105091, 4509006 (V), 2401020, 4419008.	
Deviatori	art. 4201010.	
Aste verticali	art. 3305015, 3305016, 3305002, 4509003 (V), 3305013, 990837.	
Riscontro serratura	art. 2401006, 2401005, 2401015, 2401014, 4509006 (V), 2401006, 2401035, 3412001.	
Comandi esterni	art. BM, BSP, BS, BMC, BC, B, A, BM inox, BM alu, BSP inox, BSP alu	
Sistema di allestimento della conformità	1	Attestation of conformity
Norma di riferimento	EN1125:2008	Standard
Classificazione	3   7   7   B   1   3   2   1   A   A	Classification
<b>Eventuali estensioni</b>	<b>Nessuna / None</b>	<b>Extensions</b>
<b>Eventuali condizioni di subordinazione della Certificazione CE</b>	<b>Nessuna / None</b>	<b>Possible conditions of subordination of the CE Certification</b>
<small>Il presente attestato è valido esclusivamente per il prodotto indicato. Eventuali varianti da apportare devono essere approvate da ICIM SpA</small>		
<small>The present issue is valid only for the product described above. Possible changes to be brought in have to be approved by ICIM S.p.A.</small>		
<b>Data di emissione</b> First issue	<b>Emissione corrente</b> Current issue	<b>Data di scadenza</b> Expiring date
18/04/2007	04/08/2010	17/04/2017
		 <b>ICIM S.p.A.</b> Il Presidente Ing. Tullio Badino

### EXUS® LP IN BLACK NYLON



#### Description

The EXUS LP panic exit device consists of an anodized aluminum horizontal bar that inserts into the lever arms attached to the command mechanisms which activate the lock.

- Reversible for right or left opening
- For application to single leaf and two-leaved doors
- Suited for Rever/Univer/Proget doors and other types of panic exit doors
- The horizontal bar is made of extruded anodized aluminum with an elliptical cross-section measuring 40 x 20 mm and a length of 1150 mm
- Two black nylon lever arms with galvanized steel core
- The two command mechanisms are made of galvanized steel with black nylon cover plates, one of which has an EXIT label that identifies the lock side
- The lock is anti-panic/fire rated for Euro profile cylinders
- External door furniture and the backplate are made of black nylon, while the internal installation plate is made of galvanized steel
- DC version with double cylinder to pass

### VERSIONS AVAILABLE

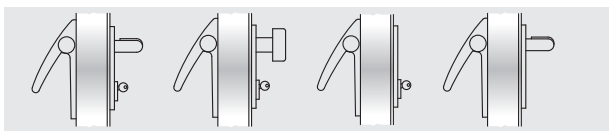

BM

BSP

BS

BMC



BC

B

A

DC BM

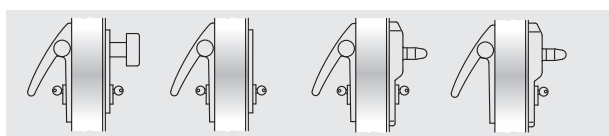

DC BSP

DC BS

DC ELM

ELM

### VARIATIONS ON REQUEST (see dedicated page)

- Aluminum bar painted in RAL colors
- External BM and BSP door furnitures in satinized stainless steel
- External BM and BSP door furnitures painted in RAL colors
- MAC1 panic lock with access control system, combinable with the BM and DC BM versions
- Mastered or coded cylinders
- Microswitch and cable sleeve for signaling when the door is open

### EXUS LP (SUPPLIED WITH THE DOOR)

#### For single leaves or the active leaf (main leaf) of two-leaved doors:

*Included (mounted on the door):*

*Included (in the package):* Nr. 2 door command mechanisms, Nr. 2 black nylon carter covers, Nr. 2 black nylon lever arms, Nr. 1 anodized aluminum bar, Nr. 1 black nylon door furniture, Nr. 1 half-cylinder with 3 keys, Nr. 1 double cylinder with 3 keys (DC version only), Nr. 1 drilling template, Nr. 1 adhesive pictogram (green arrow), Nr. 1 set of installation/maintenance instructions

*Versions available:* BM, BSP, BS, BMC, BC, B (for Proget doors only), DC BM, DC BSP, DC BS, DC ELM, ELM.

ELM electric handle: see the dedicated pages

#### For the secondary leaf of two-leaved doors:

*Included (mounted on the door):* anti-panic safety lock with 80 mm entrance, the upper re-latch device, the upper strike plate and the vertical rods

*Included (in the package):* Nr. 2 command mechanisms, Nr. 2 black nylon carter covers, Nr. 2 black nylon lever arms, Nr. 1 anodized aluminum bar, Nr. 1 floor-mounted floor catch, Nr. 1 companion arm (for fire doors only), Nr. 1 drilling template, Nr. 1 adhesive pictogram (green arrow), Nr. 1 set of installation/maintenance instructions

*Versions available:* A

### EXUS LP KIT

#### (SUPPLIED SEPARATELY FROM THE DOOR)

#### KIT for single leaf or the active leaf of two-leaved doors:

Please specify leaf thickness and door type - REVER, UNIVER or PROGET - in the order

*KIT contents:* Nr. 1 anti-panic lock with 65 mm entrance, Nr. 1 strike plate insert, Nr. 2 command mechanisms, Nr. 2 black nylon carter covers, Nr. 2 black nylon lever arms, Nr. 1 anodized aluminum bar, Nr. 1 black nylon external door furniture, Nr. 1 half-cylinder with 3 keys, Nr. 1 double cylinder with 3 keys (DC version only), Nr. 1 drilling template, Nr. 1 adhesive pictogram (green arrow), Nr. 1 set of installation/maintenance instructions

*Versions available:* BM, BSP, BS, BMC, BC, DC BM, DC BSP, DC BS

#### KIT for the passive leaf of two-leaved doors, suited for REVER, UNIVER and PROGET fire and multipurpose doors (produced after 01.01.2005):

specify door type on the order form  
*KIT contents:* Nr. 1 anti-panic safety lock with 80 mm entrance, Nr. 2 command mechanisms, Nr. 2 black nylon carter covers, Nr. 2 black nylon lever arms, Nr. 1 anodized aluminum bar, Nr. 1 upper re-latch device, Nr. 1 floor-mounted floor catch, Nr. 1 companion arm (excluding REVER and UNIVER MULTIPURPOSE), Nr. 1 drilling template, Nr. 1 adhesive pictogram (green arrow), Nr. 1 set of installation/maintenance instructions

*Versions available:* A

#### KIT for the passive leaf of two-leaved doors and suited for other types of multipurpose doors:

*KIT contents:* Nr. 1 anti-panic safety lock with 80 mm entrance, Nr. 2 command mechanisms, Nr. 2 black nylon carter covers, Nr. 2 black nylon lever arms, Nr. 1 anodized aluminum bar, Nr. 1 upper re-latch device, Nr. 1 upper strike plate, Nr. 1 angular support bracket, Nr. 1 upper rod, Nr. 1 lower rod, Nr. 2 extension rods, Nr. 1 floor-mounted floor catch, Nr. 1 companion arm, Nr. 1 drilling template, Nr. 1 adhesive pictogram (green arrow), Nr. 1 set of installation/maintenance instructions

*Versions available:* A

## EXUS® LA IN ALUMINUM



### Description

The EXUS LA panic bar consists of an anodized aluminum horizontal bar that inserts into lever arms attached to the command mechanisms which activate the lock.

- Reversible for right or left opening
- For application to single leaf and two-leaved doors
- Suited for Rever/Univer/Proget doors and other types of panic exit doors
- The horizontal bar is made of extruded anodized aluminum with an elliptical cross-section measuring 40 x 20 mm and a length of 1150 mm
- The two lever arms are made of an aluminum alloy with a polished chrome finish
- The two command mechanisms are made of galvanized steel with aluminum alloy cover plates with a polished chrome finish, one of which has an EXIT label to identify the lock side
- The lock is anti-panic/fire rated for Euro profile cylinders
- The door furniture consist of the AISI 304 stainless steel handle or knob and the aluminum alloy backplate with polished chrome finish
- The arms, backplates and handle caps are finished with tri-valent chrome in compliance with the ROSH regulation
- DC version with double cylinder to pass

### VERSIONS AVAILABLE

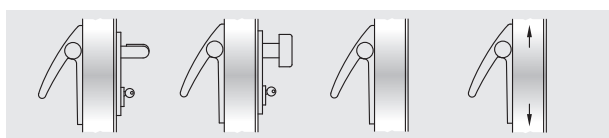

BM

BSP

B

A

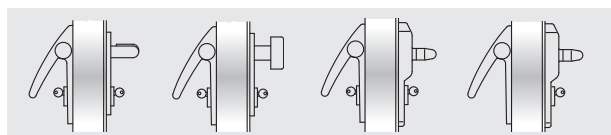

DC BM

DC BSP

DC ELM

ELM

### VARIATIONS ON REQUEST (see dedicated page)

- Aluminum bar painted in RAL colors
- MAC1 panic lock with access control system, combinable with the BM and DC BM versions
- Mastered or coded cylinders
- Microswitch and cable sleeve for signaling when the door is open

## EXUS LA (SUPPLIED WITH THE DOOR)

### For single leaves or the active leaf (main leaf) of two-leaved doors:

*Included (mounted on the door):* the anti-panic lock with 65 mm entrance and the backplate insert

*Included (in the package):* Nr. 2 command mechanisms, Nr. 2 polished chrome aluminum carter covers, Nr. 2 polished chrome aluminum lever arms, Nr. 1 anodized aluminum bar, Nr. 1 stainless steel/aluminum door furniture, Nr. 1 half-cylinder with 3 keys, Nr. 1 double cylinder with 3 keys (DC version only), Nr. 1 drilling template, Nr. 1 adhesive pictogram (green arrow), Nr. 1 set of instructions for installation/maintenance.

*Versions available:* BM, BSP, B (for Proget doors only), DC BM, DC BSP, DC ELM, ELM.

ELM electric handle: see the dedicated pages

### For the secondary leaf of two-leaved doors:

*Included (mounted on the door):* anti-panic safety lock with 80 mm entrance, the upper re-latch device, the upper strike plate and the vertical rods

*Included (in the package):* Nr. 2 command mechanisms, Nr. 2 polished chrome aluminum carter covers, Nr. 2 polished chrome aluminum lever arms, Nr. 1 anodized aluminum bar, Nr. 1 floor-mounted floor catch, Nr. 1 companion arm (excluding REVER and UNIVER MULTIPURPOSE), Nr. 1 drilling template, Nr. 1 adhesive pictogram (green arrow), Nr. 1 set of installation/maintenance instructions

*Versions available:* A

## EXUS LA KIT

### (SUPPLIED SEPARATELY FROM THE DOOR)

#### KIT for single leaf or the active leaf of two-leaved doors:

Please specify leaf thickness and door type - REVER, UNIVER or PROGET - in the order

*KIT contents:* Nr. 1 anti-panic lock with 65 mm entrance, Nr. 1 strike plate insert, Nr. 2 command mechanisms, Nr. 2 polished chrome aluminum carter covers, Nr. 2 polished chrome aluminum lever arms, Nr. 1 anodized aluminum bar, Nr. 1 stainless steel/aluminum external door furniture, Nr. 1 half-cylinder with 3 keys, Nr. 1 double cylinder with 3 keys (DC version only), Nr. 1 drilling template, Nr. 1 adhesive pictogram (green arrow), Nr. 1 set of installation/maintenance instructions

*Versions available:* BM, BSP, DC BM, DC BSP

#### KIT for the passive leaf of two-leaved doors, suited for REVER, UNIVER and PROGET fire and multipurpose doors (produced after 01.01.2005):

specify door type on the order form  
*KIT contents:* Nr. 1 anti-panic safety lock with 80 mm entrance, Nr. 2 command mechanisms, Nr. 2 polished chrome aluminum carter covers, Nr. 2 polished chrome aluminum lever arms, Nr. 1 anodized aluminum bar, Nr. 1 upper re-latch device, Nr. 1 floor-mounted floor catch, Nr. 1 companion arm (excluding REVER and UNIVER MULTIPURPOSE), Nr. 1 drilling template, Nr. 1 adhesive pictogram (green arrow), Nr. 1 set of installation/maintenance instructions

*Versions available:* A

#### KIT for the passive leaf of two-leaved doors and suited for other types of multipurpose doors:

*KIT contents:* Nr. 1 anti-panic safety lock with 80 mm entrance, Nr. 2 command mechanisms, Nr. 2 chromed aluminum carter covers, Nr. 2 chromed aluminum lever arms, Nr. 1 anodized aluminum bar, Nr. 1 upper re-latch device, Nr. 1 upper strike plate, Nr. 1 angular support bracket, Nr. 1 upper rod, Nr. 1 lower rod, Nr. 2 extension rods, Nr. 1 floor-mounted floor catch, Nr. 1 companion arm, Nr. 1 drilling template, Nr. 1 adhesive pictogram (green arrow), Nr. 1 set of installation/maintenance instructions

*Versions available:* A

## EXUS® LX IN STAINLESS STEEL



### Description

The entire EXUS LX panic bar is made of stainless steel, and consists of a horizontal bar that inserts into lever arms attached to the command mechanisms which activate the lock.

- Maximum corrosion resistance and noteworthy robustness of the entire set
- Optimal aesthetic appearance
- Reversible for right or left opening
- For application to single leaf and two-leaved doors
- Suited for Rever/Univer/Proget doors and other types of panic exit doors
- The horizontal bar is made of AISI 304 satinized stainless steel with an elliptical cross-section measuring 40 x 20 mm, length of 1150 mm
- The two lever arms are made of AISI 304 satinized stainless steel
- The two command mechanisms are made of AISI 304 stainless steel
- The two backplates and the cover caps are made of AISI 304 satinized stainless steel, and one is labeled with EXIT to identify the lock side
- The lock is anti-panic/fire rated for Euro profile cylinders
- The door furnitures and related backplate are made of AISI 304 satinized stainless steel, while the internal installation plate is made of galvanized steel
- DC version with double cylinder to pass

## VERSIONS AVAILABLE

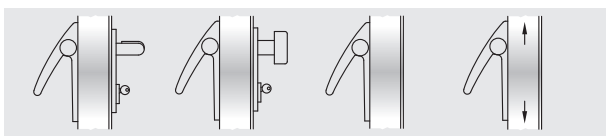

BM

BSP

B

A

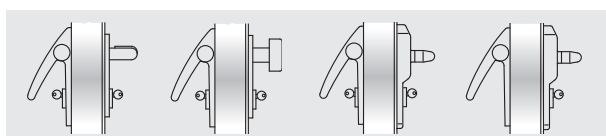

DC BM

DC BSP

DC ELM

ELM

## VARIATIONS ON REQUEST (see dedicated page)

- MAC1 panic lock with access control system, combinable with the BM and DC BM versions
- Mastered or coded cylinders
- Microswitch and cable sleeve for signaling when the door is open

## EXUS LX (SUPPLIED WITH THE DOOR)

### For single leaves or the active leaf (main leaf) of two-leaved doors:

*Included (mounted on the door):* the anti-panic lock with 65 mm entrance and the backplate insert

*Included (in the package):* Nr. 2 stainless steel command mechanisms, Nr. 2 stainless steel carter covers, Nr. 2 stainless steel lever arms, Nr. 1 stainless steel bar, Nr. 1 stainless steel door furniture, Nr. 1 half-cylinder with 3 keys, Nr. 1 double cylinder with 3 keys (DC version only), Nr. 1 drilling template, Nr. 1 adhesive pictogram (green arrow), Nr. 1 set of installation/maintenance instructions

*Versions available:* BM, BSP, B (for Proget doors only), DC BM, DC BSP, DC ELM, ELM.

ELM electric handle: see the dedicated pages

### For the secondary leaf of two-leaved doors:

*Included (mounted on the door):* anti-panic safety lock with 80 mm entrance, the upper re-latch device, the upper strike plate and the vertical rods

*Included (in the package):* Nr. 2 stainless steel command mechanisms, Nr. 2 stainless steel carter covers, Nr. 2 stainless steel lever arms, Nr. 1 stainless steel bar, Nr. 1 floor-mounted floor catch, Nr. 1 companion arm (for fire doors only), Nr. 1 drilling template, Nr. 1 adhesive pictogram (green arrow), Nr. 1 set of installation/maintenance instructions

*Versions available:* A

## EXUS LX KIT

### (SUPPLIED SEPARATELY FROM THE DOOR)

#### KIT for single leaf or the active leaf of two-leaved doors:

Please specify leaf thickness and door type - REVER, UNIVER or PROGET - in the order

*KIT contents:* Nr. 1 reversible anti-panic lock with 65 mm entrance, Nr. 1 strike plate insert, Nr. 2 stainless steel command mechanisms, Nr. 2 stainless steel carter covers, Nr. 2 stainless steel lever arms, Nr. 1 stainless steel bar, Nr. 1 stainless steel external door furniture, Nr. 1 half-cylinder with 3 keys, Nr. 1 double cylinder with 3 keys (DC version only), Nr. 1 drilling template, Nr. 1 adhesive pictogram (green arrow), Nr. 1 set of installation/maintenance instructions

*Versions available:* BM, BSP, DC BM, DC BSP

#### KIT for the passive leaf of two-leaved doors, suited for REVER, UNIVER and PROGET fire and multipurpose doors (produced after 01.01.2005):

specify door type on the order form

*KIT contents:* Nr. 1 anti-panic safety lock with 80 mm entrance, Nr. 2 stainless steel command mechanisms, Nr. 2 stainless steel carter covers, Nr. 2 stainless steel lever arms, Nr. 1 stainless steel bar, Nr. 1 upper re-latch device, Nr. 1 floor-mounted floor catch, Nr. 1 companion arm (excluding REVER and UNIVER MULTIPURPOSE), Nr. 1 drilling template, Nr. 1 adhesive pictogram (green arrow), Nr. 1 set of installation/maintenance instructions

*Versions available:* A

#### KIT for the passive leaf of two-leaved doors and suited for other types of multipurpose doors:

*KIT contents:* Nr. 1 anti-panic safety lock with 80 mm entrance, Nr. 2 stainless steel command mechanisms, Nr. 2 stainless steel carter covers, Nr. 2 stainless steel lever arms, Nr. 1 stainless steel bar, Nr. 1 upper re-latch device, Nr. 1 upper strike plate, Nr. 1 angular support bracket, Nr. 1 upper rod, Nr. 1 lower rod, Nr. 2 extension rods, Nr. 1 floor-mounted floor catch, Nr. 1 companion arm, Nr. 1 drilling template, Nr. 1 adhesive pictogram (green arrow), Nr. 1 set of installation/maintenance instructions

*Versions available:* A

# Twist

TWIST



## PRESENTATION

### TWIST panic bars

TWIST panic bars are **CE** marked in accordance with European standard EN 1125:2008, which entered in effect January 01, 2010, and which prescribes a series of substantial changes that further extend the requirements for maximum safety and ease of opening.

### The KIT designed for your needs

When ordered separately from the door, the **TWIST** series of panic bars is provided in elegant and functional **KITs** packaged for presentation in the most appropriate format for distribution.

Packaging in **KITs** ensures customers, installers and therefore the final users that they are receiving a complete anti-panic system with fully corresponding parts that are all **CE** certified.

### Finishing

The **TWIST** panic exit device series is proposed in a **black NYLON** version combined with an **anodized ALUMINUM** bar. On request, the bar and the door furniture may be painted in RAL colors, opening up an infinite variety of aesthetic solutions.

### Certifications and replacements

Given the importance of maintaining the entire system's **CE** conformity, special attention has been paid to replacement parts, which have been subjected to testing in accordance with the EN 1125:2008 standard due to their pivotal role in maintaining **CE** certification.

The only way to ensure that the products maintain their original characteristics over time is by using **original NINZ replacement parts**.

For this reason, the instructions for **TWIST** panic bars include additional indications regarding proper installation and maintenance plus an explosion assembly drawing that specifies every smallest detail of the certified system with all of the references required for ordering replacement parts.

With the new packaging of the TWIST panic exit device, NINZ S.p.A. demonstrates its intent to believe in market development by investing in designs and company image in order to endow its own products with added value while maintaining highly competitive quality-price ratios.

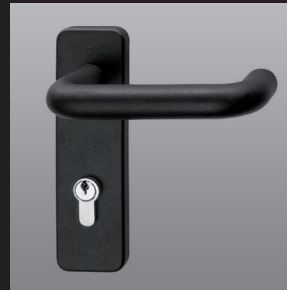

Black NYLON handle

### NOTE

The TWIST exit device series is combined with a black NYLON handle.

# TWIST - Features, certifications

Panic bar



## FEATURES

- The classic line of panic bars, an ever-green, available in the standard combination with black nylon arms/caps and anodized aluminum bar
- Certified for internal locks with a 65 mm entrance for single leaves or active leaves, and with an 80 mm entrance for secondary leaves
- Reversible for mounting on Right or Left doors
- Protrusion 100 mm
- Proposed together with the door or separately in a complete KIT packaged in a single black/green box
- Packaging is labeled to identify product characteristics
- Wide range of customizations: colored bar, colored or stainless steel handles, locks with access control systems, special coded or mastered cylinders

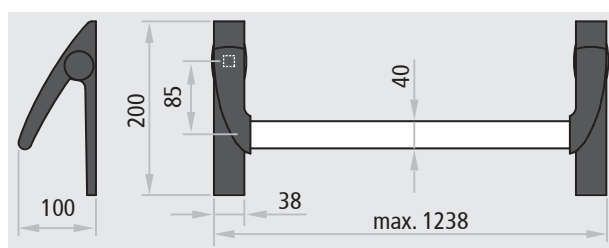

Also suited for doors with fire ratings:



## CERTIFICATION

Suited for one-leaved doors or the active and secondary leaves of two-leaved doors with dimensions up to 1350 x 2880 mm/leaf, masses of 300 kg/leaf

<b>Denomination</b>	TWIST PANIC BAR
<b>Manufacturer</b>	Ninz S.p.A. Corso Trento, 2/A I-38061 ALA (TN)/ITALY
<b>Year application trademark</b>	08
<b>Nr. and year of the standard</b>	EN 1125:2008
<b>Certifying body</b>	0425
<b>CE certificate Nr.</b>	1228-CPD-2007
<b>Classification</b>	<b>3 7 7 B 1 3 2 1 A A</b>

- 1st Category of use very frequent
- 2nd Durability 200.000 cycles
- 3rd Door mass over 200 kg
- 4th Suitable for fire/smoke rated doors
- 5th Safety, suitable for evacuation routes
- 6th High corrosion resistance 96 h
- 7th Material safety 1000 N
- 8th Bar protrusion up to 150 mm
- 9th Activation type with push bar
- 10th Suitable for one- or two-leaved doors

ATTESTATO N°		1228 - CPD - 2007		CERTIFICATE N°	
Organismo notificato			Notified Body		
ICIM S.p.A. - Piazza Don Mapelli, 75 - 20099 Sesto San Giovanni (MI) ITALY			Identification number: 0425		
Dati Fabbricante			Manufacturer		
Sede legale: NINZ S.p.A. Corso Trento, 2/A - 38061 ALA (TN) ITALY			Head office		
Unità operativa			Operative unit		
Dati prodotto				Product	
Tipologia: DISPOSITIVI ANTIPANICO PER USCITE DI SICUREZZA AZIONATI MEDIANTE UNA BARRA ORIZZONTALE				Type	
Denominazione: Dispositivo antipanico serie "TWIST" "EXUS LP" "EXUS LA" "EXUS LX"				Denomination	
Serrature antipanico art. AP1618, SCA 1 3201001 016020, MAC 1 3201001 041042, 4506002.17 (V), 3201001.018, 485-65-0.					
Controserrature antipanico art. AP020P, AP020U, 4506003.18 (V), 3201001.6, 43160.95.					
Dispositivo superiore art. 3105080, 3105024, 4506003 (V), 3305033.					
Riscontro asta art. 2401036, 2401046, 2401044, 4506005 (V), 2401002.					
Boccola pavimento art. 2401001, 2401007, 3105091, 4506006 (V), 2401020, 4419008.					
Deviatori art. 4201010.					
Asse verticali art. 3305015, 3305016, 3305002, 4506003 (V), 3305013, 990837.					
Riscontro serratura art. 2401005, 2401005, 2401015, 2401014, 4506006 (V), 2401006, 2401035, 3412001.					
Comandi esterni art. BM, BSP, BS, BMC, BC, B, A, BM inox, BM alu, BSP inox, BSP alu.					
Sistema di attestazione della conformità		1		Attestation of conformity	
Norma di riferimento		EN1125:2008		Standard	
Classificazione		3   7   7   B   1   3   2   1   A   A		Classification	
Eventuali estensioni			Nessuna / None		
Eventuali condizioni di subordinazione della Certificazione CE			Nessuna / None		
Sistema di attestazione della conformità			1		
Norma di riferimento			EN1125:2008		
Classificazione			3   7   7   B   1   3   2   1   A   A		
Eventuali estensioni			Nessuna / None		
Eventuali condizioni di subordinazione della Certificazione CE			Nessuna / None		
Il presente attestato è valido esclusivamente per il prodotto indicato. Eventuali varianti da apportare devono essere approvate da ICIM S.p.A. The present issue is valid only for the product described above. Possible changes to be brought in have to be approved by ICIM S.p.A.					
Data di emissione First issue		Emissione corrente Current issue		Data di scadenza Expiring date	
18/04/2007		04/08/2010		17/04/2017	
 ICIM S.p.A. Il Presidente Ing. Tullio Badino					



## TWIST IN BLACK NYLON



### Description

The TWIST nylon panic bar consists of an anodized aluminum horizontal bar that inserts into the lever arms attached to the command mechanisms used to activate the lock.

- Reversible for right or left opening
- For application to single leaf and two-leaved doors
- Suited for Rever/Univer/Proget doors and other types of panic exit doors
- The horizontal bar is made of extruded anodized aluminum with an elliptical cross-section measuring 40 x 20 mm and a length of 1150 mm
- Two black nylon lever arms with galvanized steel core
- The two command mechanisms are made of galvanized steel with black nylon backplates, one of which has an EXIT label that identifies the lock side
- The lock is anti-panic/fire resistance for Euro profile cylinders
- Door furnitures and the backplate are made of black nylon, while the installation plate is made of galvanized steel

## VERSIONS AVAILABLE

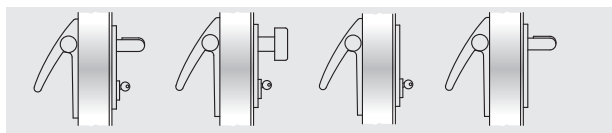

BM

BSP

BS

BMC

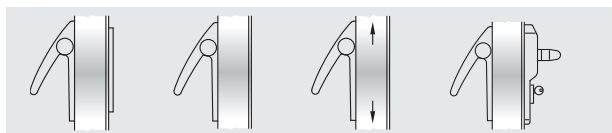

BC

B

A

ELM

## VARIATIONS ON REQUEST (see dedicated page)

- Aluminum bar painted in RAL colors
- External BM and BSP commands in satinized stainless steel
- External BM and BSP commands painted in RAL colors
- MAC1 panic lock with access control mode, combinable with the BM version
- Mastered or encrypted cylinders
- Microswitch and cable sleeve for signaling when the door is open

## TWIST (SUPPLIED WITH THE DOOR)

### For single leaves or the active leaf (main leaf) of two-leaved doors:

*Included (mounted on the door):* the anti-panic lock with 65 mm entrance and the backplate insert

*Included (in the package):* Nr. 2 command mechanisms, Nr. 2 black nylon carter covers, Nr. 2 black nylon lever arms, Nr. 1 anodized aluminum bar, Nr. 1 black nylon external door furniture door furniture, Nr. 1 half-cylinder with 3 keys, Nr. 1 drilling template, Nr. 1 adhesive pictogram (green arrow), Nr. 1 set of installation/maintenance instructions

*Versions available:* BM, BSP, BS, BMC, BC, B (for Proget doors only), ELM/mt and ELM/cisa.

ELM electric handle: see the dedicated pages

### For the secondary leaf of two-leaved doors:

*Included (mounted on the door):* anti-panic safety lock with 80 mm entrance, the upper re-latch device, the upper strike plate and the vertical rods

*Included (in the package):* Nr. 2 command mechanisms, Nr. 2 black nylon carter covers, Nr. 2 black nylon lever arms, Nr. 1 anodized aluminum bar, Nr. 1 floor-mounted door catch, Nr. 1 companion arm (for fire doors only), Nr. 1 drilling template, Nr. 1 adhesive pictogram (green arrow), Nr. 1 set of installation/maintenance instructions

*Versions available:* A

## TWIST KIT

### (SUPPLIED SEPARATELY FROM THE DOOR)

#### KIT for single leaf or the active leaf of two-leaved doors:

Please specify leaf thickness and door type - REVER, UNIVER or PROGET - in the order

*KIT contents:* Nr. 1 anti-panic lock with 65 mm entrance, Nr. 1 strike plate insert, Nr. 2 command mechanisms, Nr. 2 black nylon carter covers, Nr. 2 black nylon lever arms, Nr. 1 anodized aluminum bar, Nr. 1 black nylon external door furniture, Nr. 1 half-cylinder with 3 keys, Nr. 1 drilling template, Nr. 1 adhesive pictogram (green arrow), Nr. 1 set of installation/maintenance instructions

*Versions available:* BM, BSP, BS, BMC, BC

#### KIT for the passive leaf of two-leaved doors, suited for REVER, UNIVER and PROGET fire and multipurpose doors (produced after 01.01.2005):

specify door type on the order form

*KIT contents:* Nr. 1 anti-panic safety lock with 80 mm entrance, Nr. 2 command mechanisms, Nr. 2 black nylon carter covers, Nr. 2 black nylon lever arms, Nr. 1 anodized aluminum bar, Nr. 1 upper re-latch device, Nr. 1 floor-mounted floor catch, Nr. 1 companion arm (excluding REVER and UNIVER MULTIPURPOSE), Nr. 1 drilling template, Nr. 1 adhesive pictogram (green arrow), Nr. 1 set of installation/maintenance instructions

*Versions available:* A

#### KIT for the passive leaf of two-leaved doors and suited for other types of multipurpose doors:

*KIT contents:* Nr. 1 anti-panic safety lock with 80 mm entrance, Nr. 2 command mechanisms, Nr. 2 black nylon carter covers, Nr. 2 black nylon lever arms, Nr. 1 anodized aluminum bar, Nr. 1 upper re-latch device, Nr. 1 upper strike plate, Nr. 1 angular support bracket, Nr. 1 upper rod, Nr. 1 lower rod, Nr. 2 extension rods, Nr. 1 floor-mounted floor catch, Nr. 1 companion arm, Nr. 1 drilling template, Nr. 1 adhesive pictogram (green arrow), Nr. 1 set of installation/maintenance instructions

*Versions available:* A

**SLASH**

SLASH

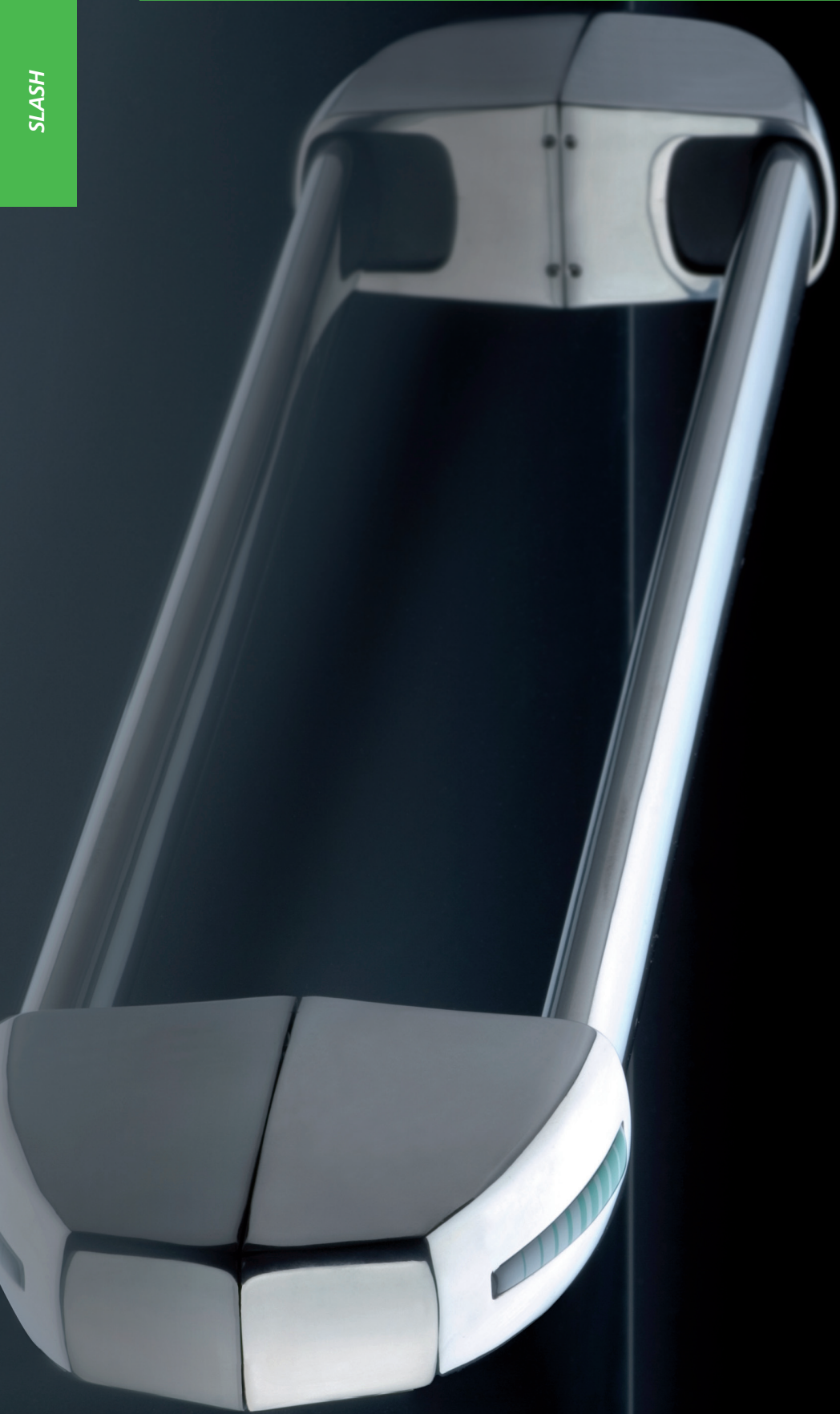

## PRESENTATION

### SLASH panic bars

Ninz S.p.A. is a leader in fire doors, and has once again reasserted itself as a visionary company with a strong identity created by its continuous research into the design and technology of its own products, such as the new line of SLASH panic bars.

All SLASH handles are **CE** marked and pre-certified according to European standard EN 1125:2008, which entered in effect January 01, 2010, to prescribe a series of substantial changes that further extend the requirements for maximum safety and ease of opening.

### The KIT designed for your needs

When ordered separately from the door, the **SLASH** series of panic bars is provided in elegant and functional KITS packaged for presentation in the most appropriate distribution format.

Packaging in KITS ensures customers, installers and therefore the final users that they are receiving a complete anti-panic system with fully corresponding parts that are all **CE** certified.

### Finishing

In addition to the **black NYLON** version combined with **anodized ALUMINUM** bars, new combinations include the **satinized STAINLESS STEEL** version and the **polished chromed ALUMINUM** version combined with the **anodized ALUMINUM bar**. Many other color and surface combinations are possible for equally aesthetic solutions.

### Certifications and replacements

Given the importance of maintaining the entire system's **CE** conformity, special attention has been paid to replacement parts, which have been subjected to testing in accordance with the EN 1125:2008 standard due to their pivotal role in maintaining **CE** certification.

The only way to ensure that the products maintain their original characteristics over time is by using **original NINZ replacement parts**.

For this reason, the instructions for **SLASH** panic bars include additional indications regarding proper installation and maintenance plus a blow-up drawing that specifies every smallest detail of the certified system with all of the references required for ordering replacement parts.

With the expansion of the line and the new packaging of the SLASH panic bar, NINZ S.p.A. demonstrates its faith in market development by investing in designs and company image in order to endow its fire doors and the series of accessories with added value while continuing to maintain highly competitive quality-price ratios.

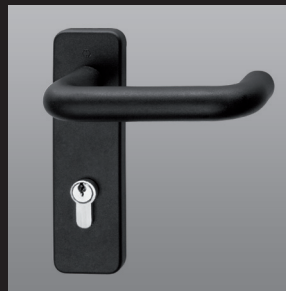

Black NYLON handle



ALUMINUM handle with STAINLESS STEEL lever handle and chromed ALUMINUM plate



Satinized STAINLESS STEEL handle

### NOTE

The external door furnitures for this series are provided with the same finishing as the panic bar.

# SLASH - Features, certifications

Panic bar



## FEATURES

- Panic bar that stands out from the others due to its particular design and the rounded shapes of the carter. This characteristic not only improves aesthetic appeal, but it also eliminates any risk of injury during use
- Available in different color and surface combinations, in satinized stainless steel for the cover carter and the bar, or with polished chromed aluminum carter and anodized aluminum bar, and then there is always the classic combination that is still in fashion - black nylon carter with anodized aluminum bar
- Certified for internal locks with a 65 mm entrance for single leaves or active leaves, and with an 80 mm entrance for passive leaves
- Reversible for Right or Left mounting
- Protrusion 75 mm
- Proposed together with the door or separately in a complete KIT packaged in a single black/orange box
- Label applied to the packaging to identify the product's characteristics
- Wide range of customizations: colored bar, colored or stainless steel handles, lock with access control mechanisms, special encrypted or mastered cylinders

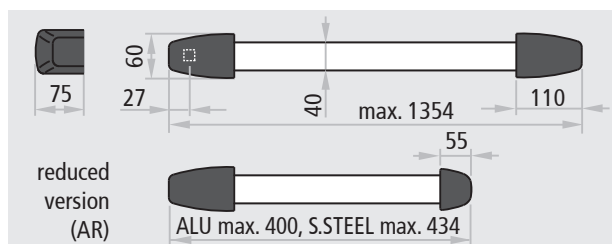

Also suited for doors with classifications up to:

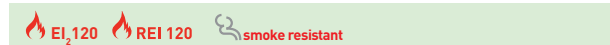

## CERTIFICATION

Suited for one-leaved doors or the active and passive leaves of two-leaved doors with dimensions up to 1350 x 2880 mm/leaf, masses of 300 kg/leaf. €€

Denomination	SLASH PANIC BAR
Manufacturer	Ninz S.p.A. Corso Trento, 2/A I-38061 ALA (TN)/ITALY
Year application trademark	08
Nr. and year of the standard	EN 1125:2008
Certifying body	0425
CE certificate Nr.	1308-CPD-2007
Classification	<b>3 7 7 B 1 3 2 2 B A</b>

- 1st Category of use very frequent
- 2nd Durability 200.000 cycles
- 3rd Door mass over 200 kg
- 4th Suitable for fire/smoke rated doors
- 5th Safety, suitable for evacuation routes
- 6th High corrosion resistance 96 h
- 7th Material safety 1000 N
- 8th Bar protrusion up to 100 mm
- 9th Activation type with touch bar
- 10th Suitable for one- or two-leaved doors

ATTESTATO DI CONFORMITÀ DIRETTIVA 89/106/CEE CERTIFICATE OF CONFORMITY DIRECTIVE 89/106/CEE		CE 0425
Questo certificato è rilasciato in conformità a quanto prescritto dall'Art.6 par.2 lettera b) del DPR 21 aprile 1993, n°246 (Direttiva 89/106/CEE) ed attesta la conformità del prodotto di seguito identificato agli Art.1, Art.2 ed allegato A del DPR 21 aprile 1993, n°246 (Direttiva 89/106/CEE). This certificate has been issued in conformity to what prescribed by the Art.6 par.2 letter b) of the DPR 21/04/1993, n°246 (Directive 89/106/EEC) and certifies the conformity of the product described below to the Art.1, Art.2 and attachment A of DPR 21/04/1993, n°246 (Directive 89/106/EEC).		
ATTESTATO N°	1308 - CPD - 2007	CERTIFICATE N°
Organismo notificato	ICIM S.p.A. - Piazza Don Mapelli, 75 - 20099 Sesto San Giovanni (MI) ITALY	Notified Body Identification number: 0425
Dati Fabbricante	NINZ S.p.A. Corso Trento, 2/A 38061 ALA (TN) ITALY	Manufacturer Head office Operative unit
Dati prodotto	DISPOSITIVI ANTIPANICO PER USCITE DI SICUREZZA AZIONATI MEDIANTE UNA BARRA ORIZZONTALE PANIC EXIT DEVICES	Product Type
Denominazione	Dispositivo antipanico Modelli "SLASH", "SLASH AR", "SLASH ALU", "SLASH ALU AR", "SLASH INOX", "SLASH INOX AR".	Denominazione
Serrature antipanico	art. APH18, SCA 1 3201001.019020; MAC 1 3201001.041042, 3201001.018, 405-95-0	
Controserrature antipanico	art. APQ20P, APQ20U, 3201001.6, 43190-95.	
Dispositivo superiore	art. 3105080, 3105024, 3309003.	
Riscontro asta	art. 2401008, 2401046, 2401044, 2401002.	
Boccola pavimento	art. 2401001, 2401007, 3105091, 2401020, 4419008.	
Deviatori	art. 4201010.	
Aste verticali	art. 3305015, 3305016, 3305002, 3305013, 990837.	
Riscontro serratura	art. 2401006, 2401005, 2401015, 2401014, 2401006, 2401008, 3412001.	
Comandi esterni	art. BM, BSP, BS, BMC, BC, B, A, BM inox, BM alu, BSP inox, BSP alu.	
Sistema di attestazione della conformità	1	Attestation of conformity
Norma di riferimento	EN1125:2008	Standard
Classificazione	3   7   7   B   1   3   2   2   B   A	Classification
Eventuali estensioni	Nessuna / None	Extensions
Eventuali condizioni di subordine della Certificazione CE	Nessuna / None	Possible conditions of subordination of the CE Certification
Il presente attestato è valido esclusivamente per il prodotto indicato. Eventuali varianti da apportare devono essere approvate da ICIM S.p.A. The present issue is valid only for the product described above. Possible changes to be brought in have to be approved by ICIM S.p.A.		
Data di emissione First issue	Emissione corrente Current issue	Data di scadenza Expiring date
31/05/2007	04/08/2010	30/05/2017
		Ing. Tullio Badino

## SLASH IN BLACK NYLON



### Description

The SLASH panic bar consists of an anodized aluminum horizontal bar and an internal connection tube that inserts into the command mechanisms which activate the lock.

- Reversible for right or left opening
- For application to single leaf and two-leaved doors
- Suited for Rever/Univer/Proget doors and other types of panic exit doors
- The horizontal bar is made of extruded anodized aluminum with an elliptical cross-section measuring 40 x 20 mm and a length of 1150 mm, equipped with a connection tube
- The two command mechanisms are made of galvanized steel with black nylon carter covers, one of which has a green label that identifies the lock side
- The lock is anti-panic/fire rated for Euro profile cylinders
- The door furnitures and the backplate are made of black nylon, while the internal installation plate is made of galvanized steel

## VERSIONS AVAILABLE

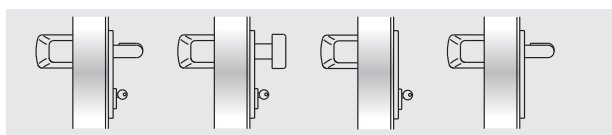

BM BSP BS BMC

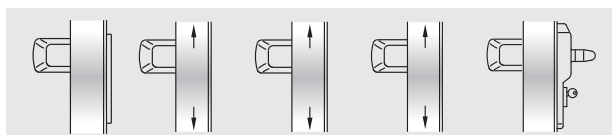

BC B A AR ELM

## VARIATIONS ON REQUEST (see dedicated page)

- Aluminum bar painted in RAL colors
- External BM and BSP commands in satinized stainless steel
- External BM and BSP commands painted in RAL colors
- MAC1 panic lock with access control mode, combinable with BM versions
- Mastered or encoded cylinders
- Microswitch and cable sleeve for signaling when the door is open

## SLASH (SUPPLIED WITH THE DOOR)

**For single leaves or the active leaf (main leaf) of two-leaved doors:**  
*Included (mounted on the door):* the anti-panic lock with 65 mm entrance and the backplate insert

*Included (in the package):* Nr. 2 command mechanisms, Nr. 2 black nylon carter covers, Nr. 1 anodized aluminum bar with connection tube and spacer, Nr. 1 backplate in RAL 9006 colored nylon with internal installation plate (for REVER and UNIVER doors), Nr. 1 black nylon external door furniture, Nr. 1 half-cylinder with 3 keys, Nr. 1 drilling template, Nr. 1 adhesive pictogram (green arrow), Nr. 1 set of installation/maintenance instructions

*Versions available:* BM, BSP, BS, BMC, BC, B (for Proget doors only), ELM/mt and ELM/cisa.

ELM electric handle: see the dedicated pages

### For the secondary leaf of two-leaved doors:

*Included (mounted on the door):* anti-panic safety lock with 80 mm entrance, the upper re-latch device, the upper strike plate and the vertical rods

*Included (in the package):* Nr. 2 command mechanisms, Nr. 2 black nylon carter covers, Nr. 1 anodized aluminum bar with connection tube and spacer, Nr. 1 floor-mounted floor catch, Nr. 1 companion arm (for fire doors only), Nr. 1 drilling template, Nr. 1 adhesive pictogram (green arrow), Nr. 1 set of installation/maintenance instructions

*Versions available:* A, AR (reduced) for secondary leaves with FM L2 width ≤ 500mm

## SLASH KIT

### (SUPPLIED SEPARATELY FROM THE DOOR)

#### KIT for single leaf or the active leaf of two-leaved doors:

Please specify leaf thickness and door type - REVER, UNIVER or PROGET - in the order

*KIT contents:* Nr. 1 anti-panic lock with 65 mm entrance, Nr. 1 strike plate insert, Nr. 2 command mechanisms, Nr. 2 black nylon carter covers, Nr. 1 anodized aluminum bar with connection tube and spacer, Nr. 1 backplate in RAL 9006 colored nylon with internal installation plate, Nr. 1 black nylon door furniture, Nr. 1 half-cylinder with 3 keys, Nr. 1 drilling template, Nr. 1 adhesive pictogram (green arrow), Nr. 1 set of installation/maintenance instructions

*Versions available:* BM, BSP, BS, BMC, BC

#### KIT for the passive leaf of two-leaved doors, suited for REVER, UNIVER and PROGET fire and multipurpose doors (produced after 01.01.2005):

specify door type on the order form  
*KIT contents:* Nr. 1 anti-panic safety lock with 80 mm entrance, Nr. 2 command mechanisms, Nr. 2 black nylon carter covers, Nr. 1 anodized aluminum bar with connection tube and spacer, Nr. 1 upper re-latch device, Nr. 1 floor-mounted floor catch, Nr. 1 companion arm (excluding REVER and UNIVER MULTIPURPOSE), Nr. 1 drilling template, Nr. 1 adhesive pictogram (green arrow), Nr. 1 set of installation/maintenance instructions

*Versions available:* A, AR (reduced) for use with passive leaves with FM L2 width ≤ 500mm

#### KIT for the passive leaf of two-leaved doors and suited for other types of multipurpose doors:

*KIT contents:* Nr. 1 anti-panic safety lock with 80 mm entrance, Nr. 2 command mechanisms, Nr. 2 black nylon carter covers, Nr. 1 anodized aluminum bar with connection tube and spacer, Nr. 1 upper re-latch device, Nr. 1 upper strike plate, Nr. 1 angular support bracket, Nr. 1 upper rod, Nr. 1 lower rod, Nr. 2 extension rods, Nr. 1 floor-mounted floor catch, Nr. 1 companion arm, Nr. 1 drilling template, Nr. 1 adhesive pictogram (green arrow), Nr. 1 set of installation/maintenance instructions

*Versions available:* A, AR (reduced) for use with passive leaves with FM L2 width ≤ 500mm

## SLASH IN ALUMINUM



### Description

The SLASH ALU panic bar consists of an anodized aluminum horizontal bar and an internal connection tube that inserts into the command mechanisms which activate the lock.

- Reversible for right or left opening
- For application to single leaf and two-leaved doors
- Suited for Rever/Univer/Proget doors and other types of panic exit doors
- The horizontal bar is made of extruded anodized aluminum with an elliptical cross-section measuring 40 x 20 mm and a length of 1150 mm, equipped with a connection tube
- The two command mechanisms are made of galvanized steel with aluminum alloy cover plates with polished chrome finishing, one of which has a green label to identify the lock side
- The lock is anti-panic/fire rated for Euro profile cylinders
- The external door furniture consist of the AISI 304 stainless steel handle or knob and aluminum alloy plate with polished chrome finish
- The carters and handle plate are finished with trivalent chrome in compliance with the ROSH regulation

## VERSIONS AVAILABLE

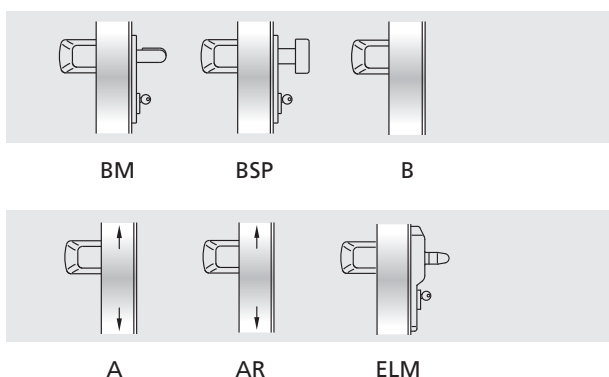

## VARIATIONS ON REQUEST (see dedicated page)

- Aluminum bar painted in RAL colors
- MAC1 panic lock with access control system, combinable with BM versions
- Mastered or encoded cylinders
- Microswitch and cable sleeve for signaling when the door is open

## SLASH ALU (FORNITO ASSIEME ALLA PORTA)

### For single leaves or the active leaf (main leaf) of two-leaved doors:

*Included (mounted on the door):* the anti-panic lock with 65 mm entrance and the backplate insert

*Included (in the package):* Nr. 2 command mechanisms, Nr. 2 polished chrome aluminum cover plates, Nr. 1 anodized aluminum bar with connection tube and spacer, Nr. 1 backplate in black nylon with internal installation plate (for REVER and UNIVER doors), Nr. 1 stainless steel/aluminum external door furniture, Nr. 1 half-cylinder with 3 keys, Nr. 1 drilling template, Nr. 1 adhesive pictogram (green arrow), Nr. 1 set of installation/maintenance instructions

*Versions available:* BM, BSP, B (for Proget doors only), ELM/mt and ELM/cisa. ELM electric handle: see the dedicated pages

### For the secondary leaf of two-leaved doors:

*Included (mounted on the door):* anti-panic safety lock with 80 mm entrance, the upper re-latch device, the upper strike plate and the vertical rods

*Included (in the package):* Nr. 2 command mechanisms, Nr. 2 polished chrome aluminum cover plates, Nr. 1 anodized aluminum bar with connection tube and spacer, Nr. 1 floor-mounted floor catch, Nr. 1 companion arm (for fire doors only), Nr. 1 drilling template, Nr. 1 adhesive pictogram (green arrow), Nr. 1 set of installation/maintenance instructions

*Versions available:* A, AR (reduced) for secondary leaves with FM L2 width ≤ 500mm

## SLASH ALU KIT

### (SUPPLIED SEPARATELY FROM THE DOOR)

#### KIT for single leaf or the active leaf of two-leaved doors:

Please specify leaf thickness and door type - REVER, UNIVER or PROGET - in the order

*KIT contents:* Nr. 1 anti-panic lock with 65 mm entrance, Nr. 1 strike box insert, Nr. 2 command mechanisms, Nr. 2 polished chrome aluminum cover plates, Nr. 1 anodized aluminum bar with connection tube and spacer, Nr. 1 backplate in black nylon with internal installation plate, Nr. 1 stainless steel/aluminum external door furniture, Nr. 1 half-cylinder with 3 keys, Nr. 1 drilling template, Nr. 1 adhesive pictogram (green arrow), Nr. 1 set of installation/maintenance instructions

*Versions available:* BM, BSP

#### KIT for the passive leaf of two-leaved doors, suited for REVER, UNIVER and PROGET fire and multipurpose doors (produced after 01.01.2005):

specify door type on the order form

*KIT contents:* Nr. 1 anti-panic safety lock with 80 mm entrance, Nr. 2 command mechanisms, Nr. 2 polished chrome aluminum cover plates, Nr. 1 anodized aluminum bar with connection tube and spacer, Nr. 1 upper re-latch device, Nr. 1 floor-mounted floor catch, Nr. 1 companion arm (excluding REVER and UNIVER MULTIPURPOSE), Nr. 1 drilling template, Nr. 1 adhesive pictogram (green arrow), Nr. 1 set of installation/maintenance instructions

*Versions available:* A, AR (reduced) for use with passive leaves with FM L2 width ≤ 500mm

#### KIT for the passive leaf of two-leaved doors and suited for other types of multipurpose doors:

*KIT contents:* Nr. 1 anti-panic safety lock with 80 mm entrance, Nr. 2 command mechanisms, Nr. 2 chromed aluminum cover plates, Nr. 1 anodized aluminum bar with connection tube and spacer, Nr. 1 upper re-latch device, Nr. 1 upper strike plate, Nr. 1 angular support bracket, Nr. 1 upper rod, Nr. 1 lower rod, Nr. 2 extension rods, Nr. 1 floor-mounted floor catch, Nr. 1 companion arm, Nr. 1 drilling template, Nr. 1 adhesive pictogram (green arrow), Nr. 1 set of installation/maintenance instructions

*Versions available:* A, AR (reduced) for use with passive leaves with FM L2 width ≤ 500mm

## SLASH IN STAINLESS STEEL



### Description

The SLASH STAINLESS STEEL panic bar consists of a stainless steel horizontal bar and an internal connection tube that inserts into the command mechanisms which activate the lock.

- Optimal corrosion and shock resistance
- State of the art aesthetics
- Secure attachment of carter
- Reversible for right or left opening
- For application to single leaf and two-leaved doors
- Suited for Rever/Univer/Proget doors and other types of panic exit doors
- The horizontal bar is made of AISI 304 satinized stainless steel with a 40 x 20 mm elliptical cross-section and a length of 1150 mm, equipped with a connection tube
- The two command mechanisms are made of galvanized steel with AISI 304 stainless steel cover plates, one of which has a green label that identifies the lock side
- The lock is anti-panic/fire rated for Euro profile cylinders
- The external door furniture and related backplate are made of AISI 304 satinized stainless steel, while the internal installation plate is made of galvanized steel

## VERSIONS AVAILABLE

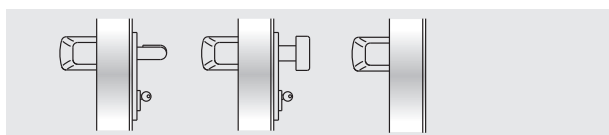

BM

BSP

B

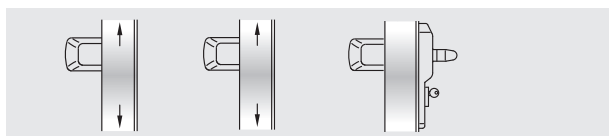

A

AR

ELM

## VARIATIONS ON REQUEST (see dedicated page)

- MAC1 panic lock with access control system, combinable with BM versions
- Mastered or coded cylinders
- Microswitch and cable sleeve for signaling when the door is open

## SLASH STAINLESS STEEL (SUPPLIED WITH THE DOOR)

### For single leaves or the active leaf (main leaf) of two-leaved doors:

*Included (mounted on the door):* the anti-panic lock with 65 mm entrance and the backplate insert

*Included (in the package):* Nr. 2 command mechanisms, Nr. 2 stainless steel cover plates, Nr. 1 stainless steel bar with connection tube and spacer, Nr. 1 backplate in black-colored nylon with internal installation plate (for REVER and UNIVER doors), Nr. 1 stainless steel external door furniture, Nr. 1 half-cylinder with 3 keys, Nr. 1 drilling template, Nr. 1 adhesive pictogram (green arrow), Nr. 1 set of installation/maintenance instructions

*Versions available:* BM, BSP, B (for Proget doors only), ELM/mt and ELM/cisa.

ELM electric handle: see the dedicated pages

### For the secondary leaf of two-leaved doors:

*Included (mounted on the door):* anti-panic safety lock with 80 mm entrance, the upper re-latch device, the upper strike plate and the vertical rods

*Included (in the package):* Nr. 2 command mechanisms, Nr. 2 stainless steel cover plates, Nr. 1 stainless steel bar with connection tube and spacer, Nr. 1 floor-mounted floor catch, Nr. 1 companion arm (for fire doors only), Nr. 1 drilling template, Nr. 1 adhesive pictogram (green arrow), Nr. 1 set of installation/maintenance instructions

*Versions available:* A, AR (reduced) for secondary leaves with FM L2 width ≤ 500mm

## SLASH STAINLESS STEEL KIT

### (SUPPLIED SEPARATELY FROM THE DOOR)

#### KIT for single leaf or the active leaf of two-leaved doors:

Please specify leaf thickness and door type - REVER, UNIVER or PROGET - in the order

*KIT contents:* Nr. 1 reversible anti-panic lock with 65 mm entrance, Nr. 1 strike plate insert, Nr. 2 command mechanisms, Nr. 2 stainless steel cover plates, Nr. 1 stainless steel bar with connection tube and spacer, Nr. 1 backplate in black nylon with internal installation plate, Nr. 1 stainless steel door furniture, Nr. 1 half-cylinder with 3 keys, Nr. 1 drilling template, Nr. 1 adhesive pictogram (green arrow), Nr. 1 set of installation/maintenance instructions

*Versions available:* BM, BSP

#### KIT for the passive leaf of two-leaved doors, suited for REVER, UNIVER and PROGET fire and multipurpose doors (produced after 01.01.2005):

specify door type on the order form  
*KIT contents:* Nr. 1 anti-panic safety lock with 80 mm entrance, Nr. 2 command mechanisms, Nr. 2 stainless steel cover plates, Nr. 1 stainless steel bar with connection tube and spacer, Nr. 1 upper re-latch device, Nr. 1 floor-mounted floor catch, Nr. 1 companion arm (excluding REVER and UNIVER MULTIPURPOSE), Nr. 1 drilling template, Nr. 1 adhesive pictogram (green arrow), Nr. 1 set of installation/maintenance instructions

*Versions available:* A, AR (reduced) for use with passive leaves with FM L2 width ≤ 500mm

#### KIT for the passive leaf of two-leaved doors and suited for other types of multipurpose doors:

*KIT contents:* Nr. 1 anti-panic safety lock with 80 mm entrance, Nr. 2 command mechanisms, Nr. 2 stainless steel cover plates, Nr. 1 stainless steel bar with connection tube and spacer, Nr. 1 upper re-latch device, Nr. 1 upper strike plate, Nr. 1 angular support bracket, Nr. 1 upper rod, Nr. 1 lower rod, Nr. 2 extension rods, Nr. 1 floor-mounted floor catch, Nr. 1 companion arm, Nr. 1 drilling template, Nr. 1 adhesive pictogram (green arrow), Nr. 1 set of installation/maintenance instructions

*Versions available:* A, AR (reduced) for use with passive leaves with FM L2 width ≤ 500mm

## COMPONENTI DEL SISTEMA CERTIFICATO

All NINZ panic bars are supplied in complete KITS to ensure conformity with EN 1125:2008 standards and **CE** certification of the product. When supplied together with the door, several of these components are already mounted

on the leaf and/or doorframe. The purpose of the following examples is to help clarify what panic bars must include to comply with certified samples.

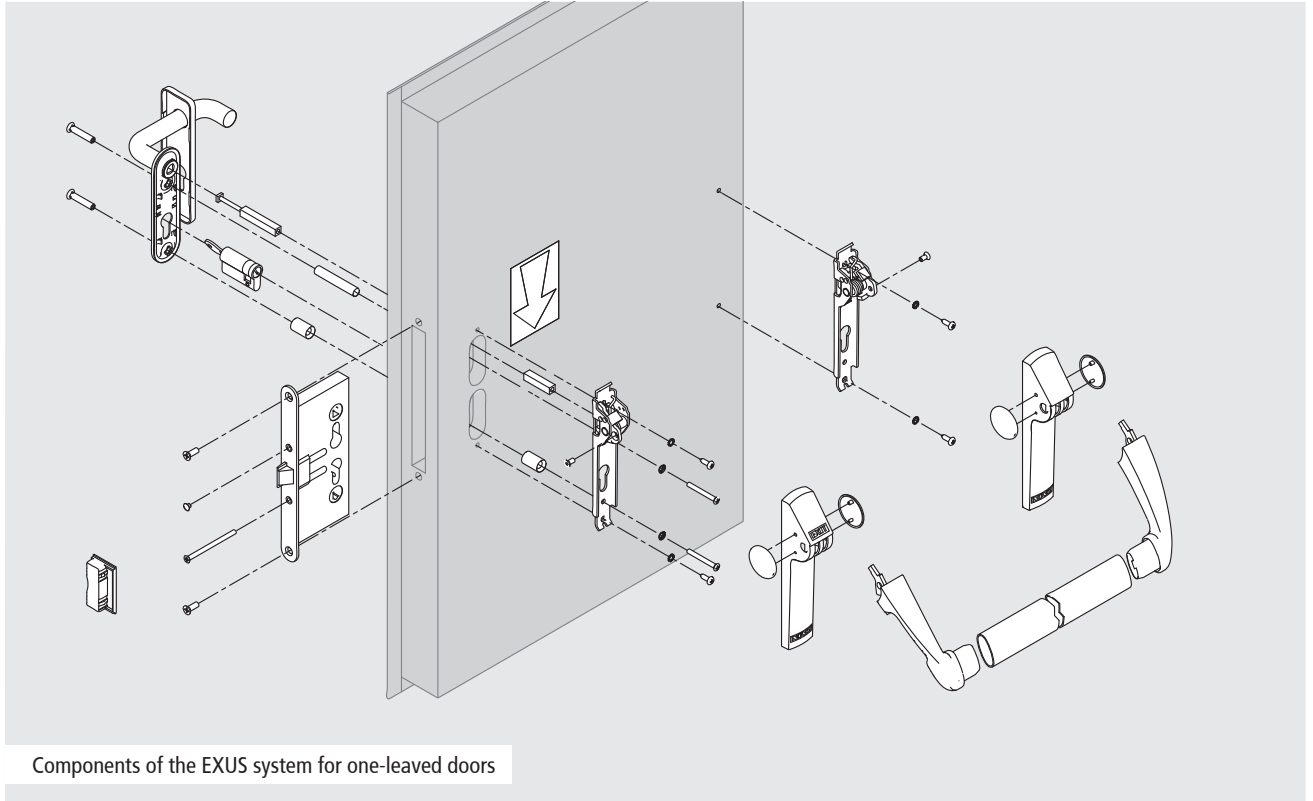

Components of the EXUS system for one-leaved doors

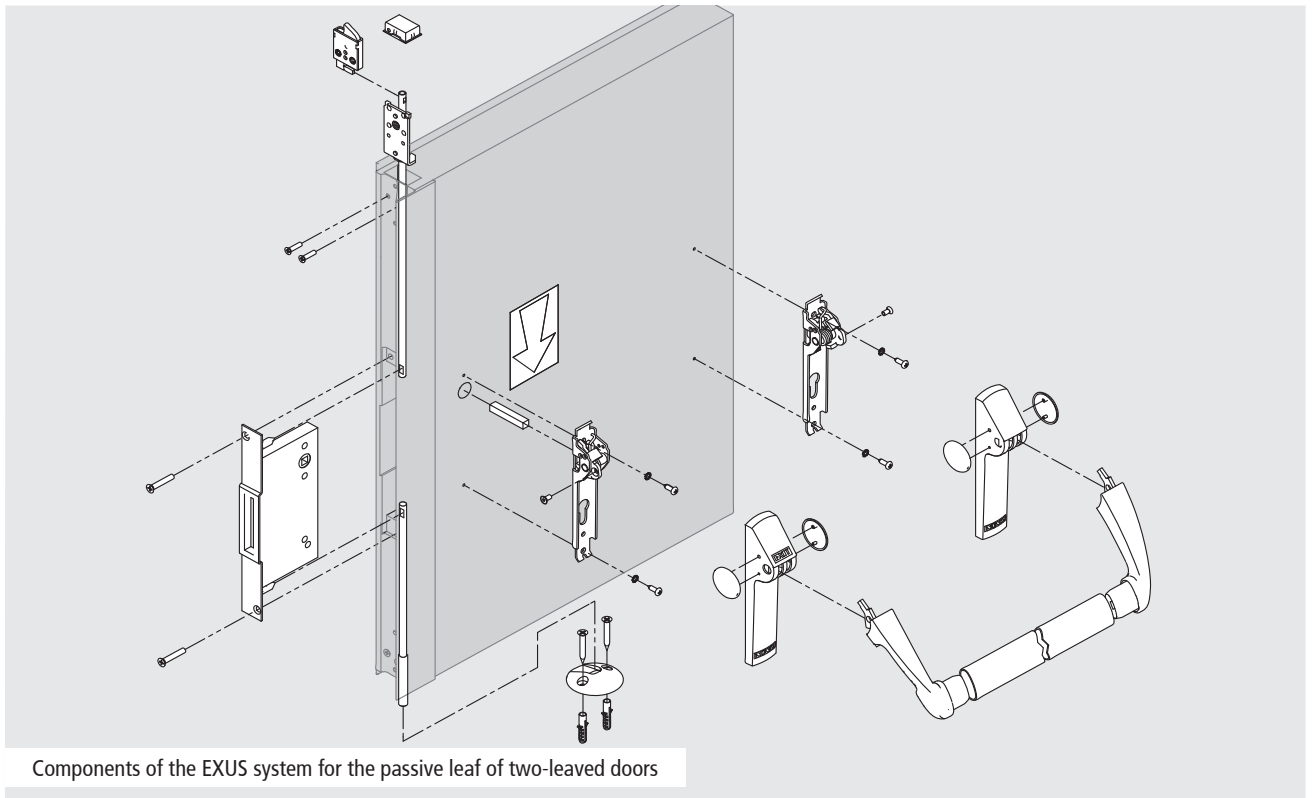

Components of the EXUS system for the passive leaf of two-leaved doors



# Variations on request

For panic bars

## STAINLESS STEEL EXTERNAL DOOR FURNITURE

For all black nylon exit devices (except for those designed for glazed doors), satinized stainless steel external BM and BSP commands are available on request.

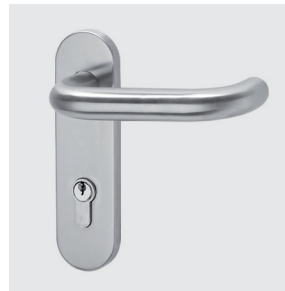

BM stainless steel

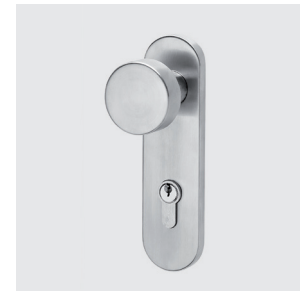

BSP stainless steel

## COLORED PLASTIC EXTERNAL DOOR FURNITURE

For all black nylon exit devices (except for those designed for glazed doors), painted polypropylene PP external BM and BSP commands are available on request.

Colors available:

RAL	RAL	RAL	RAL	RAL
1023	7016	7035	9006*	9010

\*light aluminum

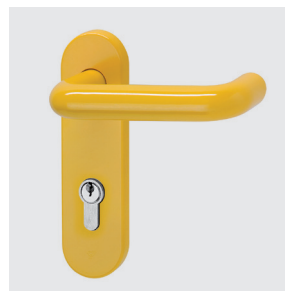

BMC colored RAL1023

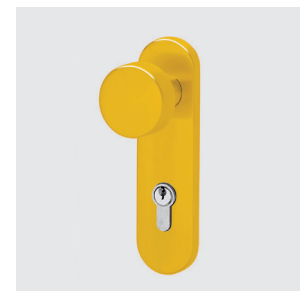

BSPC colored RAL1023

## PAINTED HORIZONTAL BAR

For all exit devices (except for those with a stainless steel bar), the aluminum horizontal bar may be painted in the RAL color of your choice.

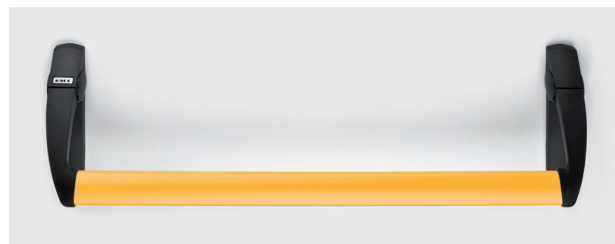

## VERSION „E“ WITH MICROSWITCH

All exit devices may be equipped with a microswitch incorporated in the hinge side mechanism for signaling when the door is open. The cable and cable sleeve for the electrical connection between the exit device and the wall are included.

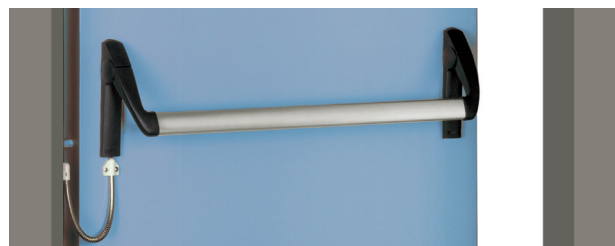

## “MAC1®” ACCESS CONTROL SYSTEM

For all exit devices with type BM external door furniture (except for those designed for glazed doors), the panic lock is also available with the access control function. The KIT contents include the MAC1 lock, the external door furniture and, when supplied together with a door, the connection cable with connector and cable sleeve. The lock is not reversible, so the opening direction of the door needs to be specified.

- MAC1: - Powered at 12-24 V DC, 12-24 V AC
- 250 mA absorption with startup at 500 mA
- Timer incorporated, time set at 30 seconds
- Possibility for continuous power supply (open setting)



Handle for MAC1 lock with LED

For sizes, information and technical data consult the dedicated pages

# Dimensional drawings

For panic exit device components

Article Nr.	Description
3201001.016	Lock for one-leaved doors and active leaves (AP 16/18)
3201001.024	Safety lock for secondary leaves (AP 020 P)
3201001.008	Safety lock for secondary leaves of UNIVER multipurpose and REVER (AP 020 U)
3201001.041	MAC1 Left lock
3201001.042	MAC1 Right lock
2401001.001	Lower floor catch for secondary leaf of PROGET and MULTIPURPOSE
3105019.001	Lower floor catch for secondary leaf of UNIVER
3105020.001	Lower floor catch for secondary leaf of REVER
2401006.001	Strike plate insert for one-leaved doors of PROGET and MULTIPURPOSE
3105080.001	Upper re-latch device for secondary leaf of PROGET and MULTIPURPOSE
3105024.001	Upper re-latch device for secondary leaf of UNIVER and REVER
2401046.001	Upper strike box for passive leaf of PROGET and MULTIPURPOSE
3305001.001	Companion arm for passive leaf

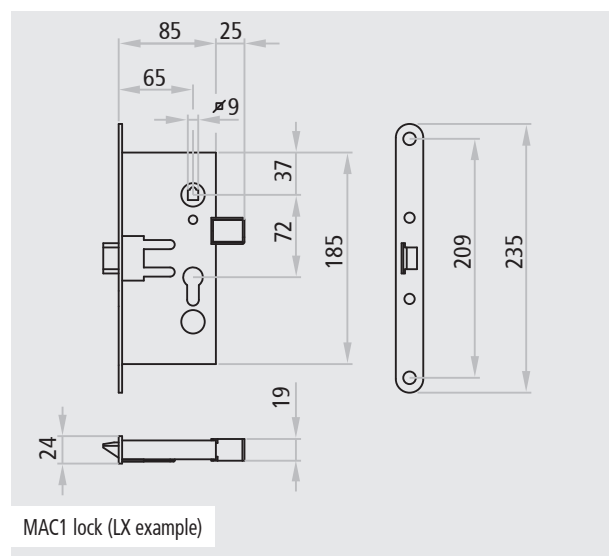
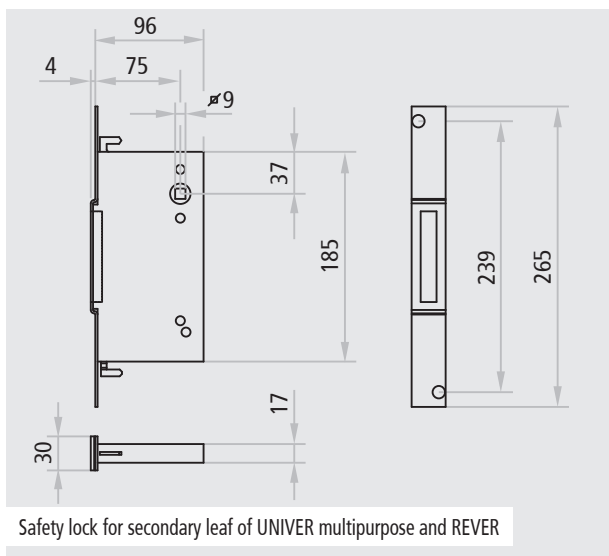
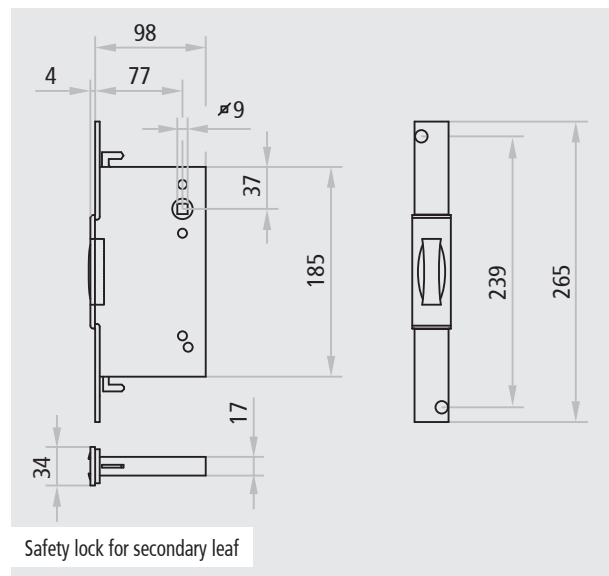
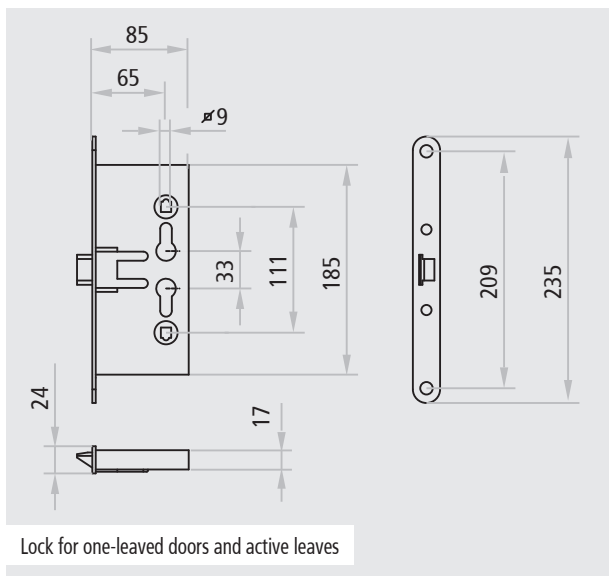

# Dimensional drawings

For panic exit device components

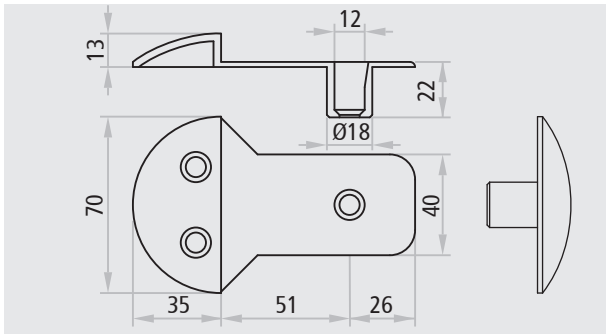

Lower floor catch for passive leaf of PROGET and MULTIPURPOSE

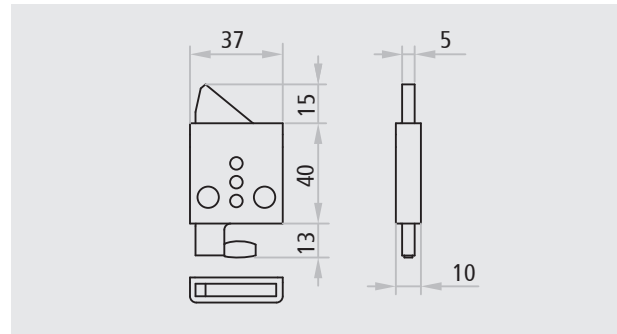

Upper re-latch device for secondary leaf of PROGET and MULTIPURPOSE

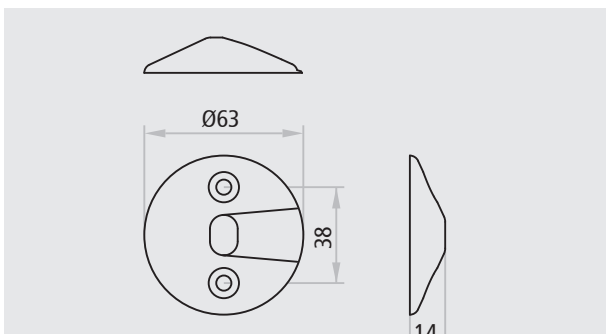

Lower floor catch for passive leaf of UNIVER

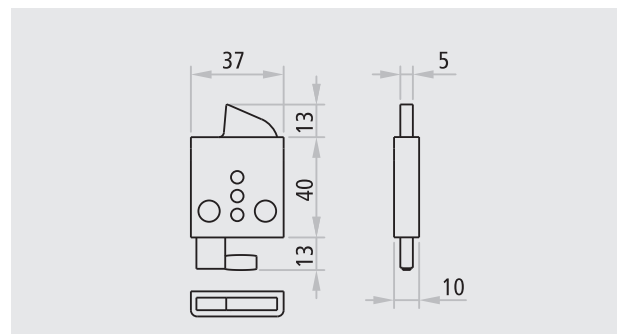

Upper re-latch device for secondary leaf of UNIVER and REVER

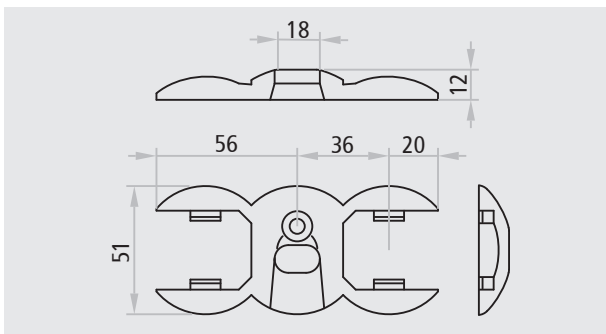

Lower floor catch for passive leaf of REVER

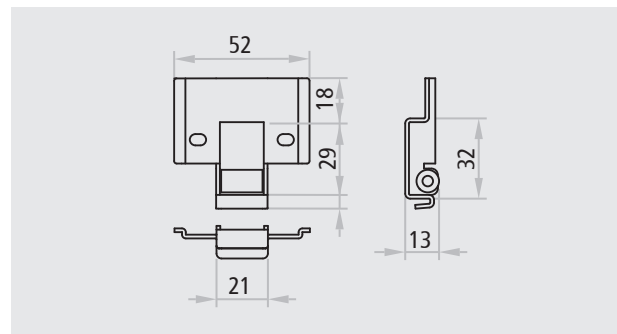

Upper strike box for secondary leaf of PROGET and MULTIPURPOSE

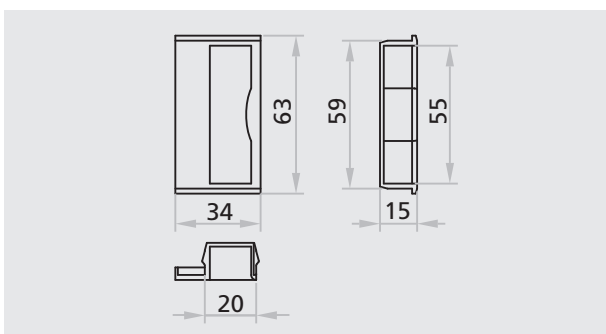

Strike plate insert for one-leaved doors of PROGET and MULTIPURPOSE

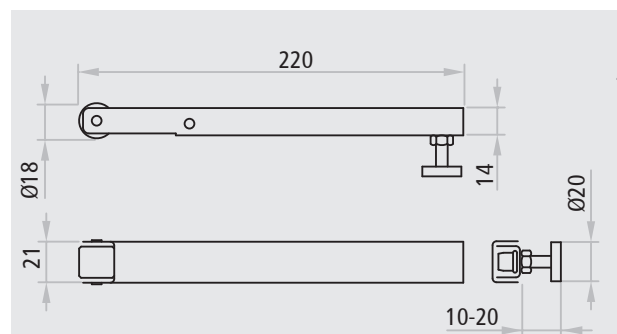

Companion arm for secondary leaf

# Notices

## For panic exit device components



### NOTICES

For panic exit devices, the human safety features are of fundamental importance in terms of their conformity with EN 1125:2008, which permits no modifications of any kind except for those described in the manufacturer's installation instructions.

All of NINZ's installation instructions for panic exit devices include a list of elements that have been tested and approved for use with panic exit devices and that can be packaged separately.

No modifications to the certified system are permitted, and every component must remain unchanged.

No uncertified components are applicable, and therefore the package contains certified components only.

Panic exit device components that are produced in conformity with European standards will provide a high level of human safety and an appropriate level of safety for material goods, as long as the doors and frames they are mounted on are in good condition.

Installation should only be carried out by qualified personnel and in strict conformity with the manufacturer's instructions.

After installation is complete, a dynamometer is used to measure the force required to release the lock by pressing on the horizontal bar and the measured forces are recorded in the maintenance register.

The instructions must be kept on file by the owner of the activity.





Ninz S.p.A. | Corso Trento 2/A | I-38061 Ala (TN)

Tel. +39 0464 678 300 | Fax +39 0464 679 025

[info@ninz.it](mailto:info@ninz.it) | [www.ninz.it](http://www.ninz.it)